

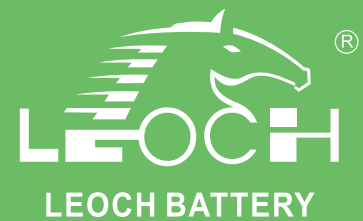

OPzV Series-Tubular Gel

5 OPzV250(2V250Ah)



Specifications

Rated Voltage	2V	
Nominal Capacity	250Ah	(C ₁₀₀ , 1.80V/cell)
Dimension	Length	124mm(4.88 in.)
	Width	206mm(8.11 in.)
	Container Height	355mm(13.97 in.)
	Total Height	390mm(15.35 in.)
Approx Weight	23.1Kg (50.93 lbs)	
Terminal	M8	
Container Material	ABS	
Rated Capacity (25°C)	250.0 Ah	(10hr, 25.0A, 1.80V/cell)
	218.0 Ah	(5hr, 43.6A, 1.75V/cell)
	193.5 Ah	(3hr, 64.5A, 1.75V/cell)
	139.5 Ah	(1hr, 139.5A, 1.67V/cell)
Max. Discharge Current (5s)	2000A	
Internal Resistance(25°C)	Approx.0.80mΩ	
Operating Temp.Range	Discharge	-20°C~55°C (-4°F~131°F)
	Charge	0°C~40°C (32°F~104°F)
	Storage	-20°C~50°C (-4°F~122°F)
Nominal Operating Temp. Range	25±3°C (77±5°F)	
Max.Charging Current(25°C)	62.5A	
Charge voltage(25°C)	Float	2.25V
	Temp. Coefficient	-3mV/cell/°C
	Cycle(Equalization)	2.35~2.40V
Effect of temp. to Capacity	40°C (104°F)	106%
	25°C (77°F)	100%
	0°C (32°F)	86%
Self Discharge	≤3% per month at 25°C	



Layout

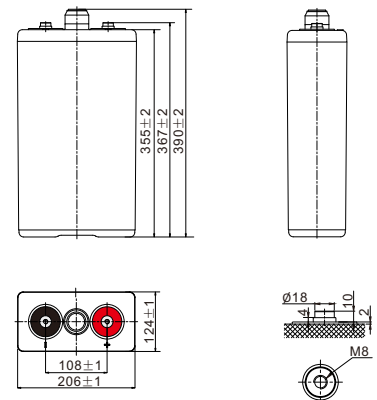

Constant Current Discharge (Amperes) at 25 °C (77°F)

F.V/Time	10min	15min	30min	1h	2h	3h	5h	8h	10h
1.85V/cell	213.0	194.0	153.0	111.7	75.6	58.0	39.7	27.8	23.4
1.80V/cell	263.0	235.0	178.0	125.3	82.8	63.1	42.8	29.8	25.0
1.75V/cell	311.0	263.0	190.0	130.2	85.6	64.5	43.6	30.3	25.4
1.70V/cell	348.0	287.0	201.0	135.9	87.8	65.8	44.3	30.7	25.7
1.67V/cell	374.0	303.0	209.0	139.5	89.2	67.0	45.0	31.0	25.9
1.60V/cell	392.0	314.0	214.0	141.6	90.7	67.8	45.4	31.3	26.1

Constant Power Discharge (Watts/cell) at 25 °C (77°F)

F.V/Time	10min	15min	30min	1h	2h	3h	5h	8h	10h
1.85V/cell	397.0	365.0	292.0	215.6	146.8	113.1	77.9	55.1	46.6
1.80V/cell	480.0	435.0	337.0	241.2	160.5	122.4	83.6	58.9	49.6
1.75V/cell	558.0	480.0	355.0	249.1	164.1	124.6	85.1	59.8	50.4
1.70V/cell	615.0	517.0	372.0	257.6	167.7	126.7	86.5	60.4	50.9
1.67V/cell	648.0	538.0	383.0	262.6	170.5	128.9	87.2	61.0	51.3
1.60V/cell	665.0	549.0	389.0	265.4	172.0	129.6	87.9	61.3	51.6



OPzV Series-Tubular Gel

5 OPzV250(2V250Ah)

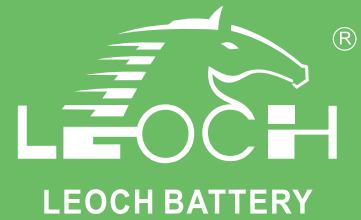

Applications

- Telecommunications
- Radio and cellular telephone relay stations
- Emergency lighting systems
- Power stations, Conventional power stations, alternative power (solar, wind)
- Large UPS and computer back-up
- Railway signaling
- Maritime standby power on ships and ashore
- Process and control engineering
- Standby power
- Buoy lighting

General Features

- 20 years design life (20°C)
- Better recovery performance
- Wide working temperature range (-20~55°C)
- No electrolyte stratification provides longer service life
- High recombination efficient
- Built in copper core based in lead will carry large current
- Separator imported from AMER-SIL high porosity, PVC-SiO₂ and low resistance
- Pasted negative plate special grid design increase the active material, availability large current discharge and charge ability
- Tubular type positive plate (polyester tube) prevent the active material from falling. Multi metal alloy pressed positive grid increase the anti corrosion ability and service life

Standards

- Compliance with IEC 60896, IEC 61427, DIN 40742 standards
- UL, CE Certified
- Manufactured in Leoch@IATF16949, OHSAS 18001, ISO 9001 and ISO 14001 certified production facilities

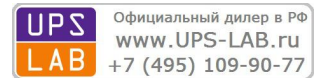

Charge voltage vs ambient temperature curve

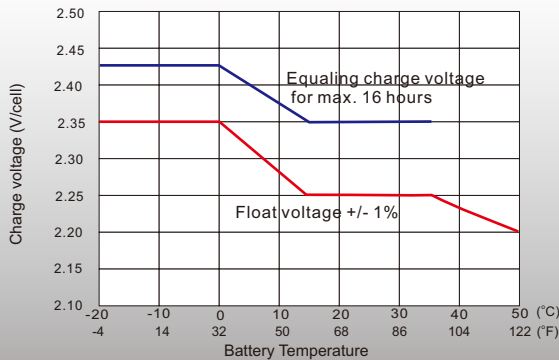

Temperature effects in relation to battery capacity

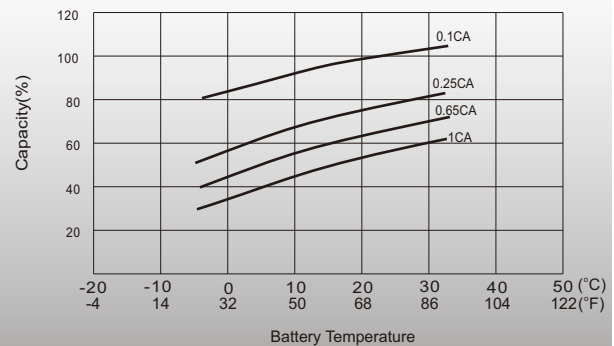

Cycle Life in Relation to DOD

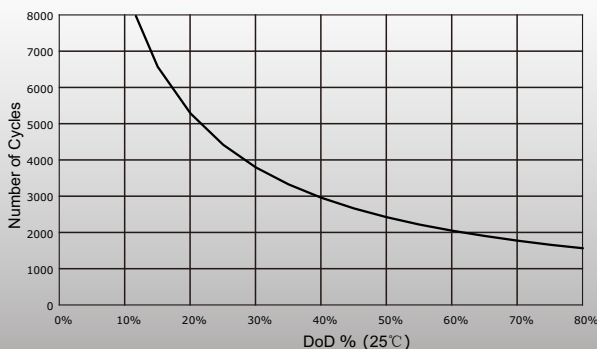

General Relation of Capacity VS. Storage Time

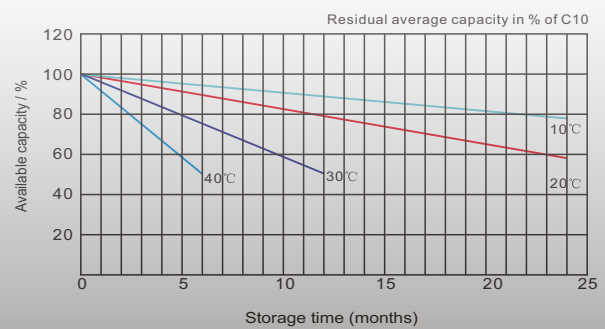

Sales Offices Worldwide

China Sales Office

5th Floor, Xinhaohui Bldg., Nanhai Blvd.,
Nanshan, Shenzhen, China. 518052
Tel: +86-755-86036060 (100 lines)
Fax: +86-755-26067269
E-mail: export@leoch.com

HongKong Sales Office

Workshop C, 33/F, TML Tower, No. 3 Hoi Shing Road,
Tsuen Wan, New Territories, Hong Kong
Tel: +852 35786666
Fax: +44 1452 690125
E-mail: sales.hk@leoch.com

Singapore Sales Office

No. 1 Tech Park Crescent,
Singapore 638131
Tel: +65 68636078
Fax: +65 6863 6079
Email: sales.sg@Leoch.com

Australia Sales Office

2/29 Tarlington Place, Smithfield. NSW 2164
Australia
Tel: 02 9756 0950
E-mail: sales.au@leoch.com

North America Sales Office

19751 Descartes
Foothill Ranch, CA 92610, USA
Tel: 949-588-5853
Fax: 949-588-5966
E-mail: sales@leoch.us

UK Sales Office

9B Wheatstone Court, Waterwells, Business Park,
Gloucester, GL2-2AQ, UK United Kingdom
Tel: +44(0) 1452 729428 / 1452 729696
Fax: +44 1452 690125
E-mail: Sales.Europe@leoch.com

EMEA Sales Office

1 Deligiorgi St., 121 31 Athens,
Greece
Tel: +30 210 5760318 (2 lines)
E-mail: support_EMEA@leoch.com

India Sales Office

Shed no.A-53(b), 2nd Stage of Peenya Industrial Area,
Bangalore North Taluk, Bangalore-560058, India
Tel: +91-80-23440018/23440019
Fax: +91-80-23440017
E-mail: indiasales@leoch.com



[Http://www.leoch.com](http://www.leoch.com)
[Http://www.leoch.us](http://www.leoch.us)

© 2019 LEOCH. All rights reserved.

Trademarks and logos are the property of LEOCH and its affiliates unless otherwise noted.
Subject to revisions without prior notice.

Publication No.:LB-5 OPzV250-PD-EN-V1.1-201906