

Product Features

- Patent composite grid structure, a smaller plate spacing design which provide high current discharge performance and high power output;
- Special active material structure technology, benefit for electrolyte rapid move;
- Optimization for positive and negative active material ratio, battery has high power ratio
- Patent multi-layer polarity sealing structure, safety and reliable leakage-proof

Application

- UPS/EPS
- Power station
- Emergency Lighting
- Universal

Compliant Standards

- GB/T 19639.1-2005;
- IEC 61056-1/2: 2002
- JIS C8702-1/2: 2009;
- Passed ISO9001、ISO14001、OHSAS18001、UL and CE certificates
- Eurobat guide;

Safety

- installation compliant with:EN50272-2

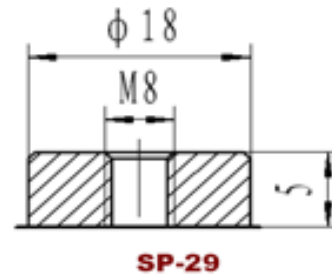
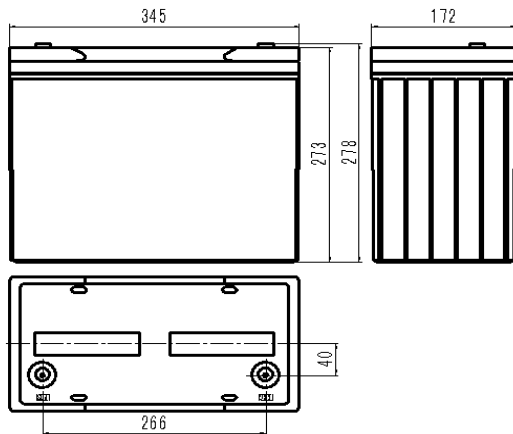
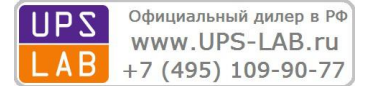

Battery Model	SPG12620W			
Designed Life	10 Years			
Capacity(25°C)	20HR(7.4A,1.80V)	10HR(13.5A,1.80V)	5HR(22.4A,1.75V)	1HR(87.7A,1.70V)
	148AH	135AH	112AH	87.7AH
Dimensions	Length	Width	Height	Total Height
	345mm	172mm	273mm	278mm
Approx. Weight	41.7kg			
Internal Resistance	3.6m Ω			
Max Discharge Current	1350A(5 Sec.)			
Self Discharge	≤2% per months (25°C)			
Charge Voltage(25°C)	Cycle use		Float use	
	14.7V(-24mV/°C), max charge current:40.5A		13.62V(-18mV/°C)	

Discharge parameter:

Constant current discharge data (25°C, A)													
End voltage (V/cell)	5min	10min	15min	20min	30min	45min	1h	1.5h	2h	3h	5h	10h	20h
1.60	440.0	337.0	282.2	233.0	185.0	135.0	98.25	72.00	57.70	42.50	25.50	15.50	8.000
1.65	410.3	317.1	268.3	224.4	176.8	127.5	92.79	68.10	55.50	40.50	24.50	14.80	7.860
1.70	384.2	296.8	254.4	217.0	168.5	120.5	87.70	64.70	53.40	39.00	23.50	14.30	7.700
1.75	359.3	277.2	242.5	209.0	159.5	114.0	82.97	61.70	51.00	37.50	22.40	13.80	7.550
1.80	332.7	259.3	230.5	198.5	151.5	109.0	79.33	57.70	49.50	35.90	21.10	13.50	7.400

Constant power discharge data (25°C, W/cell)													
End voltage (V/cell)	5min	10min	15min	20min	30min	45min	1h	1.5h	2h	3h	5h	10h	20h
1.60	740.0	620.0	490.0	392.0	316.7	235.0	188.0	133.0	106.6	80.50	54.00	31.20	16.50
1.65	700.6	590.5	470.0	376.2	306.2	227.9	182.4	129.5	104.0	78.50	52.50	30.50	16.20
1.70	674.7	563.4	451.5	361.2	296.1	221.3	176.9	125.5	101.0	76.50	51.50	30.00	16.00
1.75	642.0	534.6	433.5	346.7	285.3	214.4	171.5	121.5	98.00	74.50	50.00	29.50	15.70
1.80	612.8	509.3	416.2	332.9	276.0	208.0	166.5	118.0	95.00	72.50	48.50	28.50	15.50

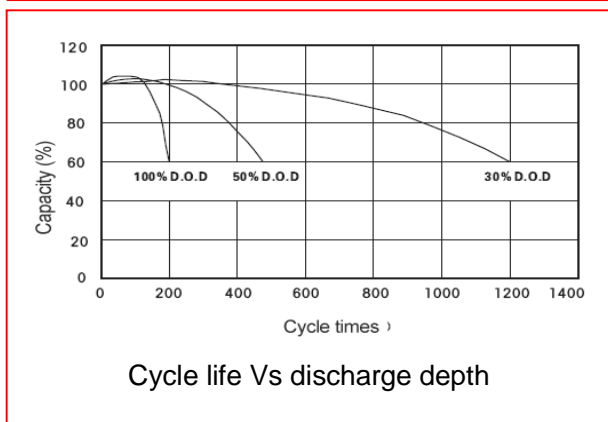
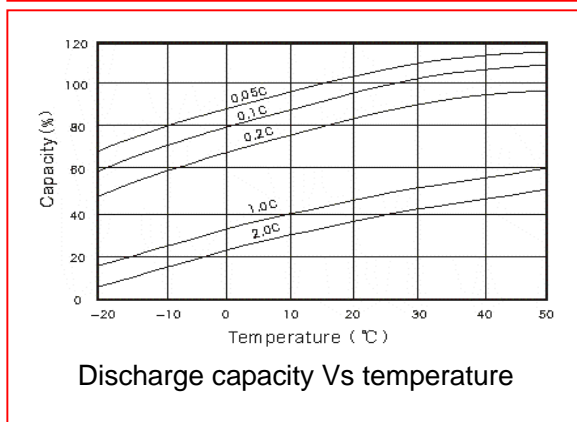
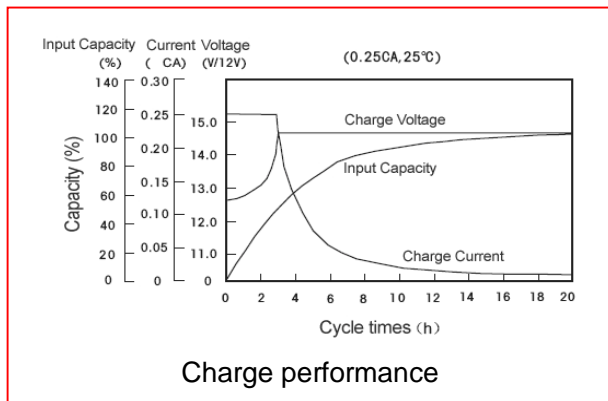
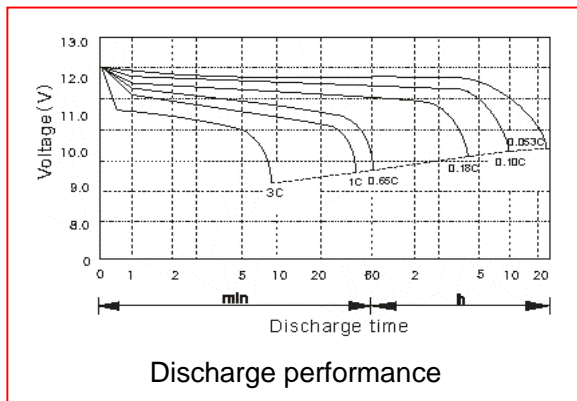
Performance Curve:

Address: NO.1 Shengyang Road, Qufu, Shandong 273100 China

Tel: +86-537-4438666-6028

Fax: +86-537-4411936

E-mail: sales@sacredsun.cn

<http://www.sacredsun.com>
