

КАПИТЕЛЬ
1.11.009



СТВОЛ
1.12.071



БАЗА
1.13.800

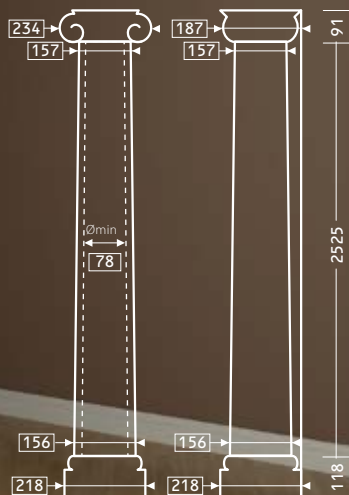
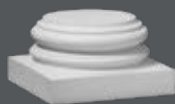

В×Г×Ш 2701×218×234

габариты конструкции в мм.

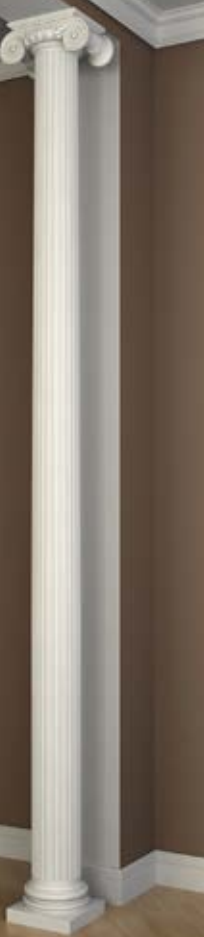

КАПИТЕЛЬ
1.11.006



СТВОЛ
1.12.050



БАЗА
1.13.500

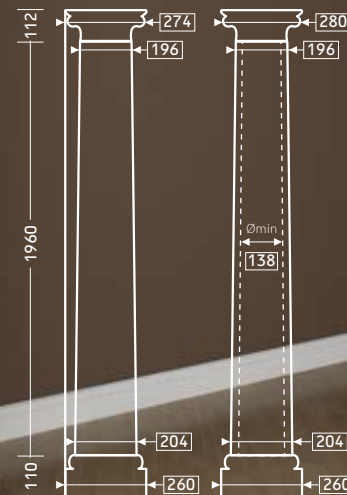

В×Г×Ш 2182×280×280

габариты конструкции в мм.

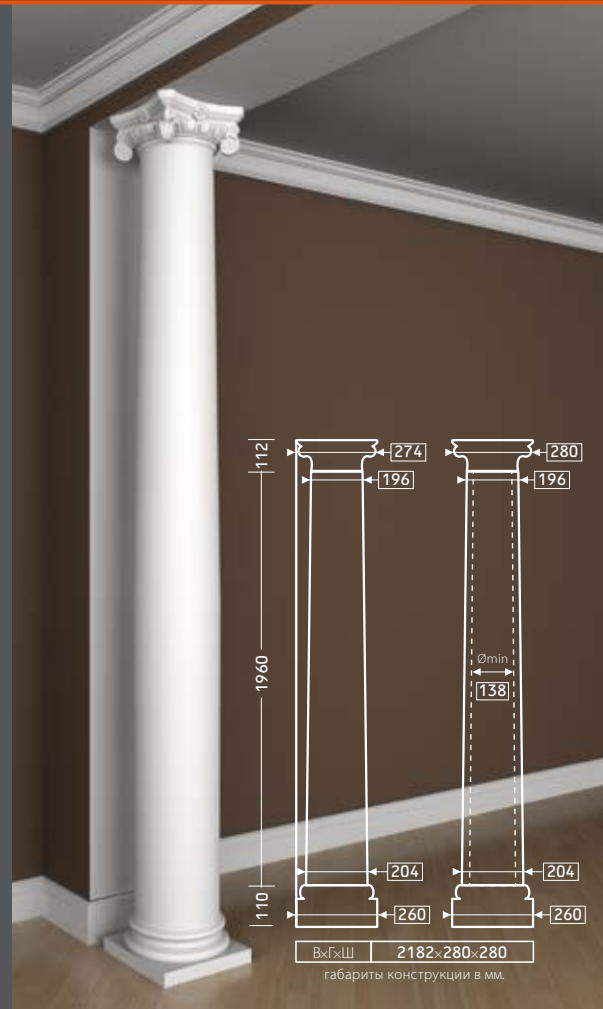

КАПИТЕЛЬ
1.11.003



СТВОЛ
1.12.010



КОЛЬЦО
1.11.100



БАЗА
1.13.100

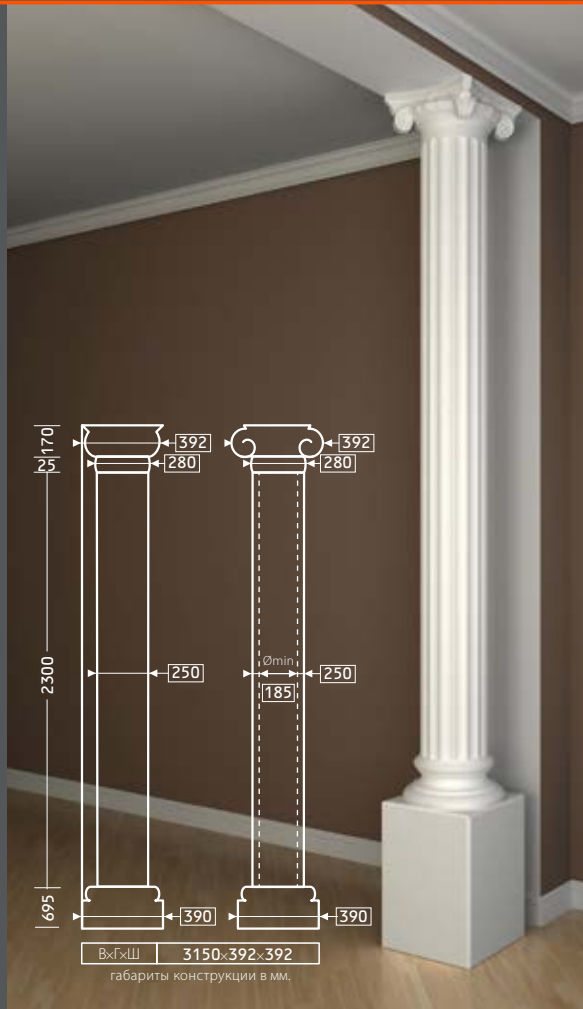

КАПИТЕЛЬ
1.11.003



СТВОЛ
1.12.010



КОЛЬЦО
1.11.100



БАЗА
1.13.200

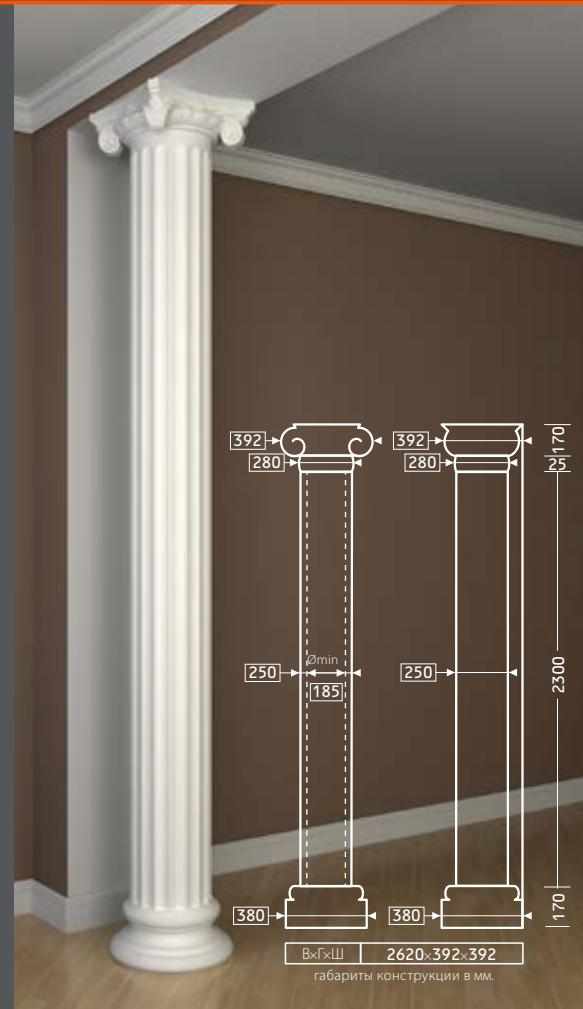
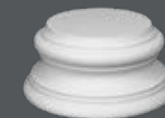

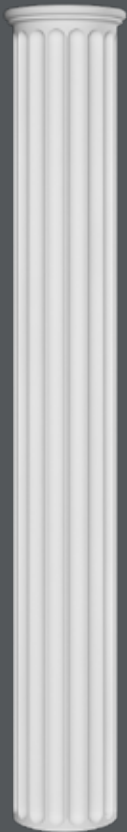
КАПИТЕЛЬ
1.11.003СТВОЛ
1.12.011БАЗА
1.13.100

ВхГхШ 3170×392×392
габариты конструкции в мм.

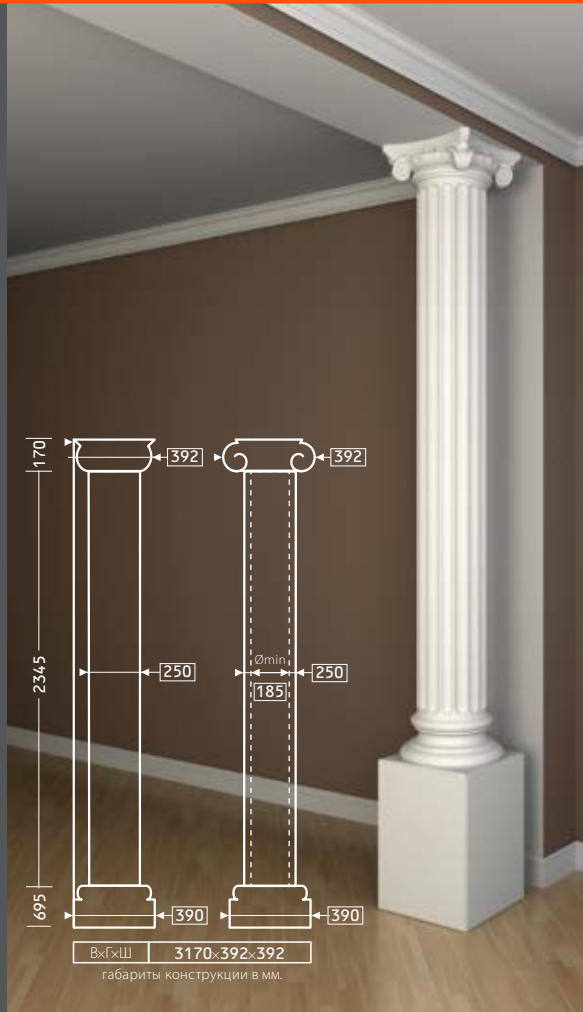
КАПИТЕЛЬ
1.11.004СТВОЛ
1.12.010КОЛЬЦО
1.11.300БАЗА
1.13.100

ВхГхШ 3219×390×440
габариты конструкции в мм.

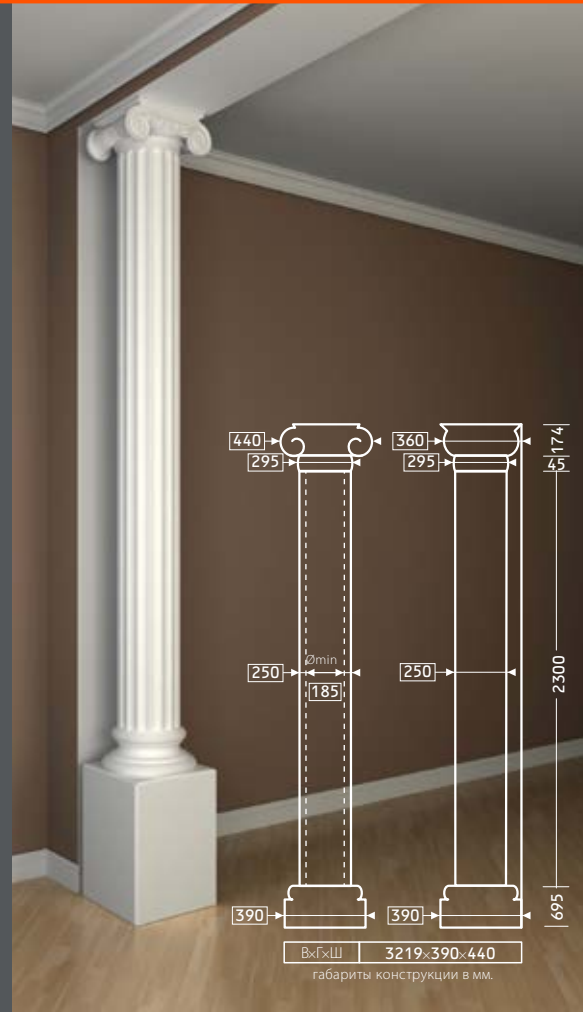

КАПИТЕЛЬ
1.11.004

СТВОЛ
1.12.010



КОЛЬЦО
1.11.300



БАЗА
1.13.200

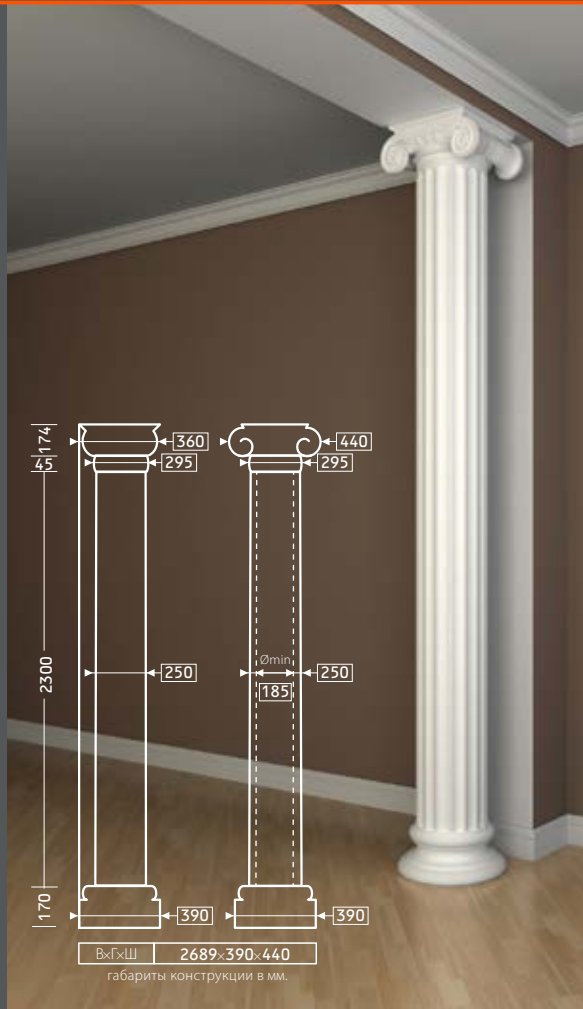
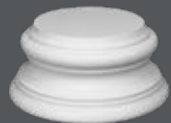

КАПИТЕЛЬ
1.11.004

СТВОЛ
1.12.011



БАЗА
1.13.200

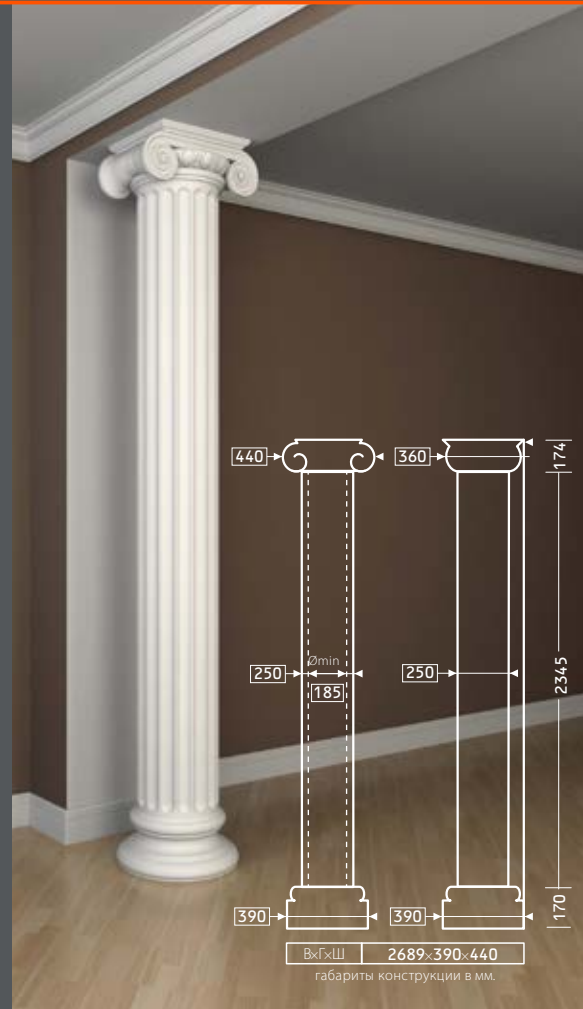

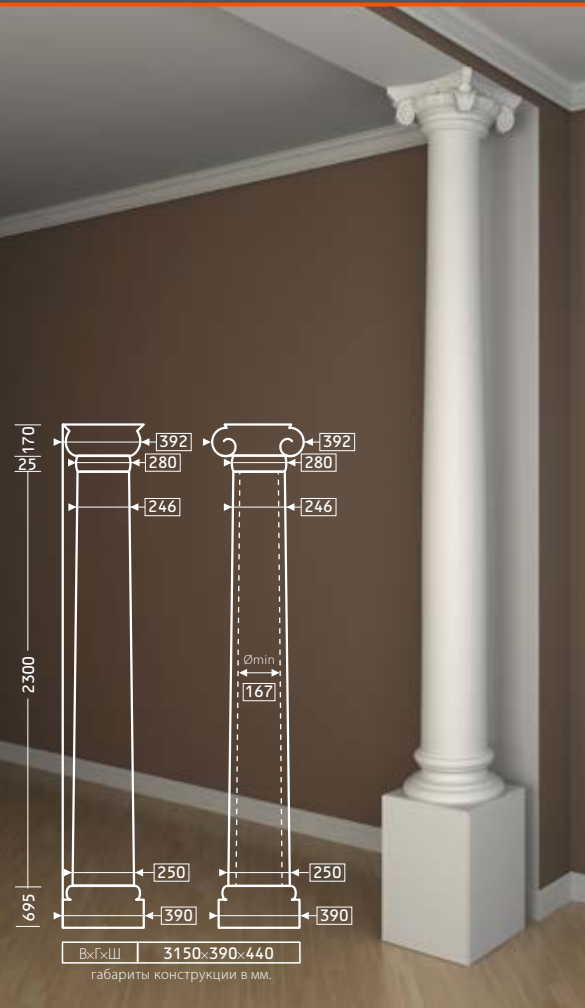
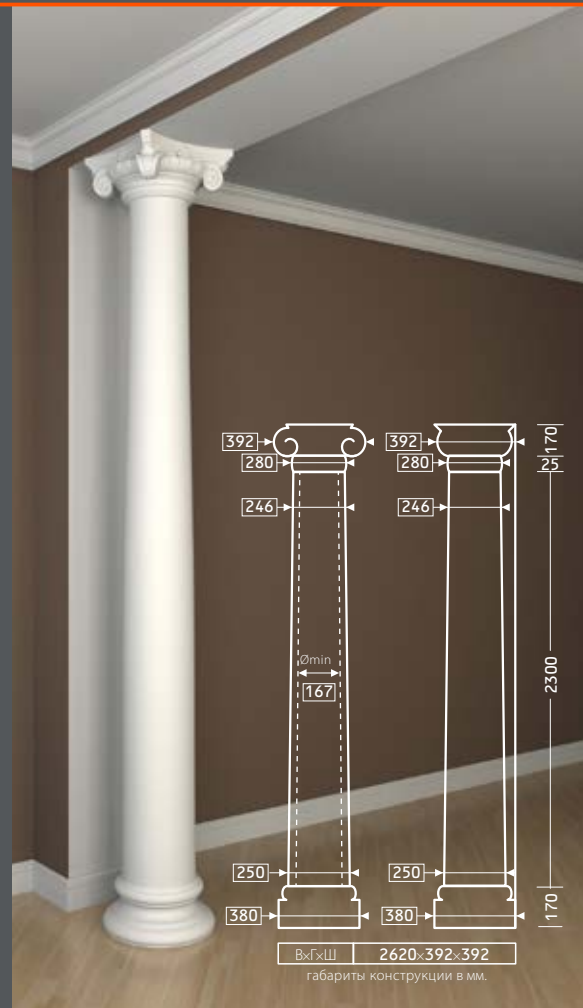
КАПИТЕЛЬ
1.11.003СТВОЛ
1.12.020КОЛЬЦО
1.11.200БАЗА
1.13.100КАПИТЕЛЬ
1.11.003СТВОЛ
1.12.020КОЛЬЦО
1.11.200БАЗА
1.13.200

КАПИТЕЛЬ 4.11.201 СТВОЛ 4.12.201



БАЗА 4.13.202

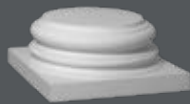

БАЗА 4.13.201

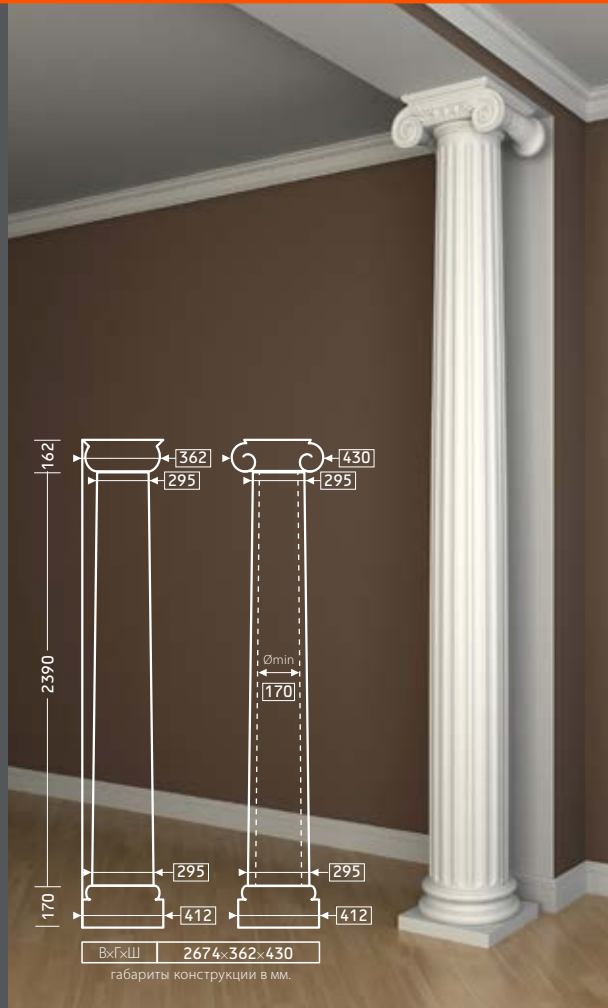
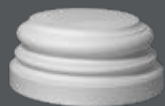

КАПИТЕЛЬ 4.11.201 СТВОЛ 4.12.202



БАЗА 4.13.202

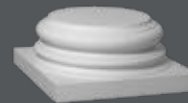

БАЗА 4.13.201

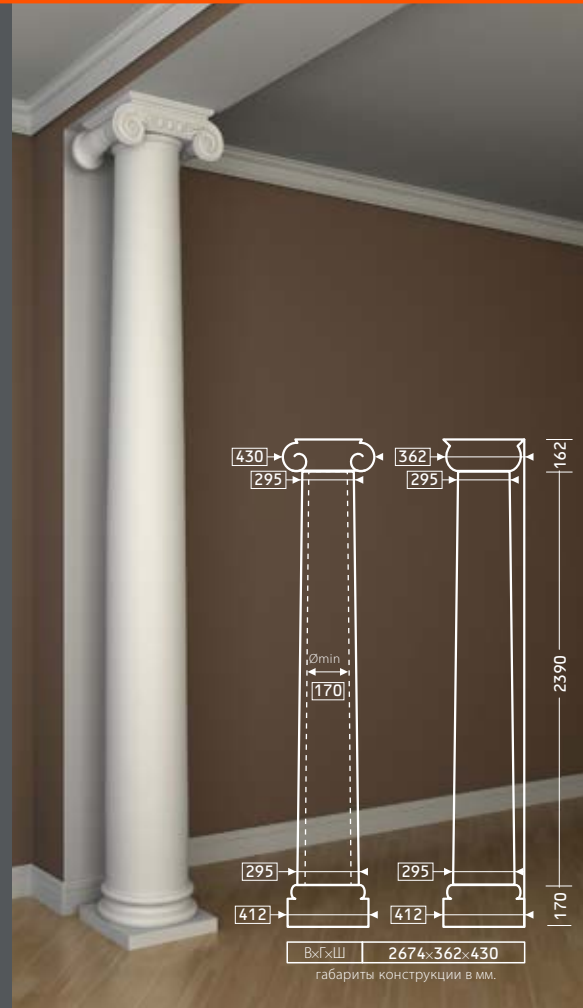
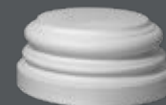

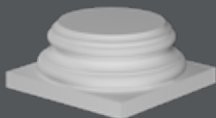
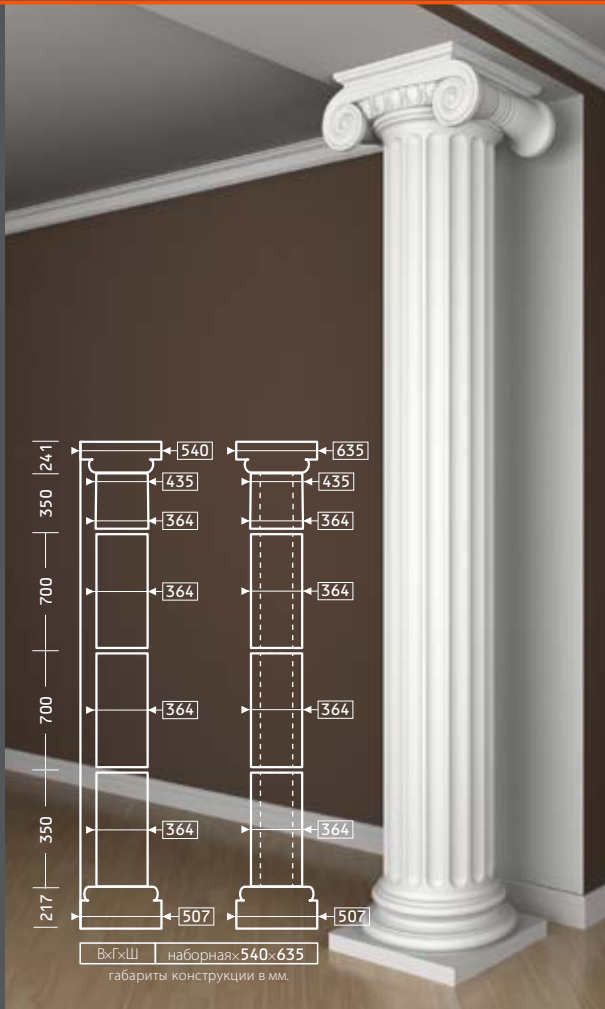
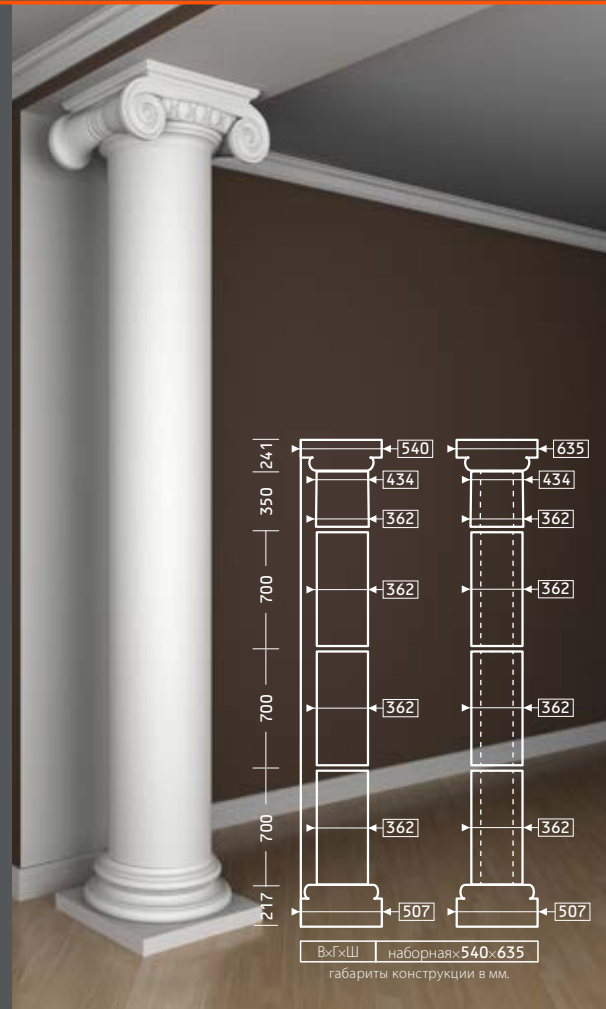
КАПИТЕЛЬ
4.11.202СТВОЛ
4.12.003БАЗА
4.13.002СТВОЛ
4.12.004СТВОЛ
4.12.005КАПИТЕЛЬ
4.11.202СТВОЛ
4.12.001БАЗА
4.13.002СТВОЛ
4.12.002

КАПИТЕЛЬ 1.11.008
СТВОЛ 1.12.060



БАЗА 1.13.700

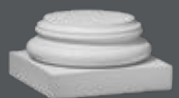

ПЬЕДЕСТАЛ 1.14.001

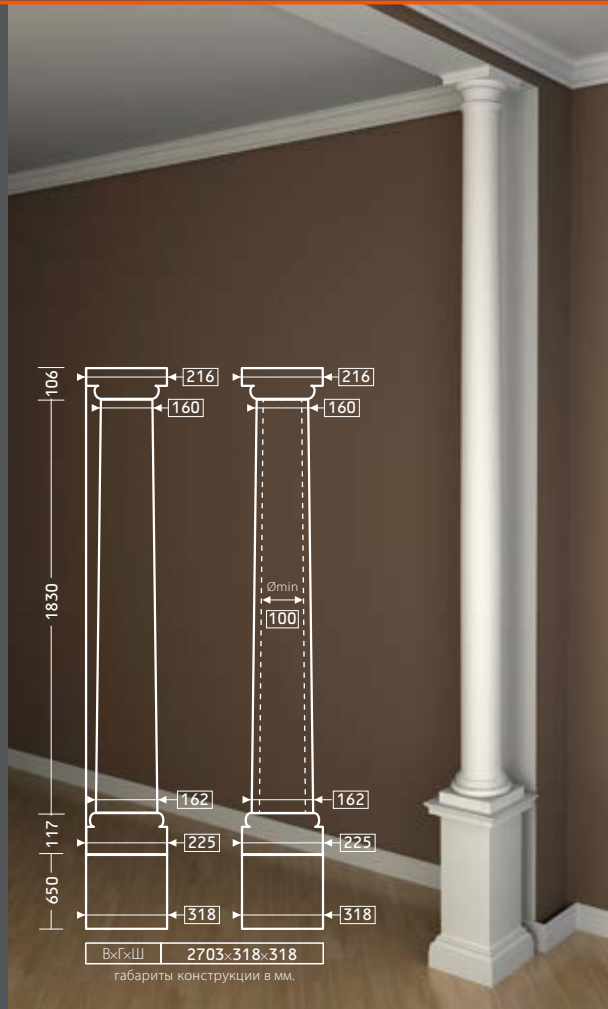

КАПИТЕЛЬ 1.11.008
СТВОЛ 1.12.061



БАЗА 1.13.700

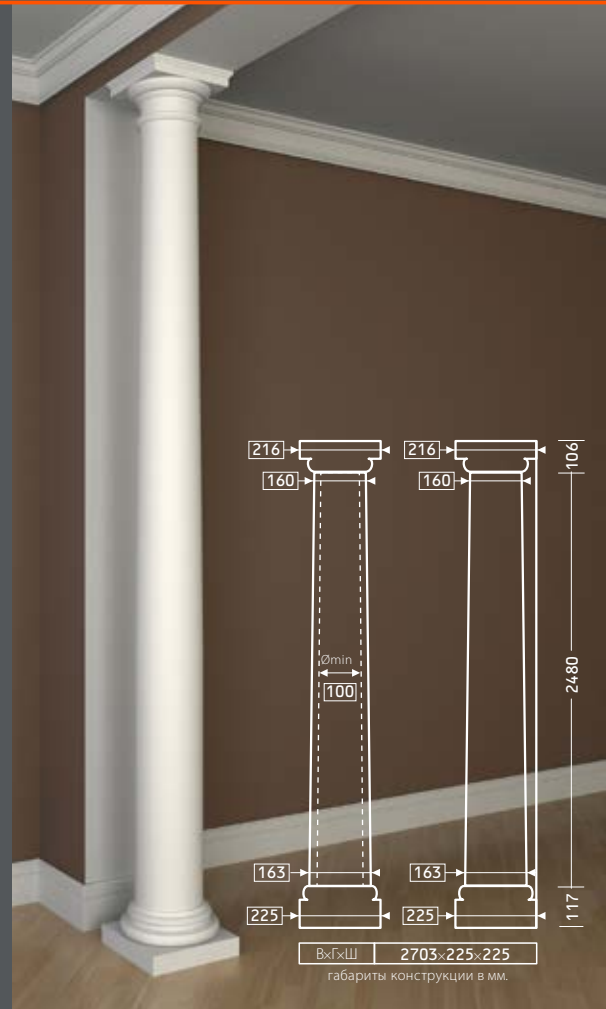
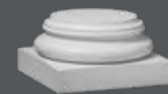

КАПИТЕЛЬ
1.11.005

СТВОЛ
1.12.050



БАЗА
1.13.500

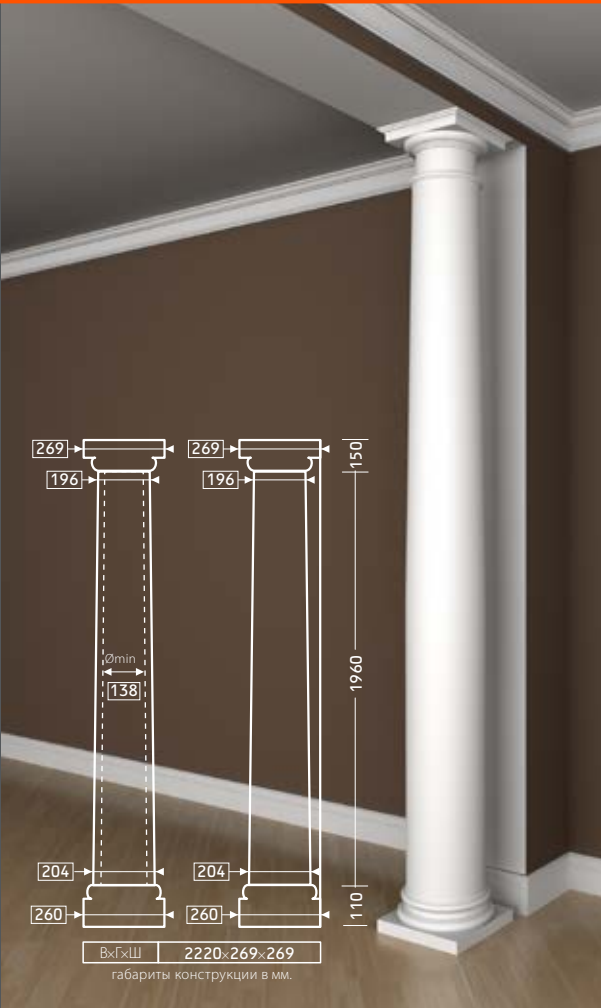
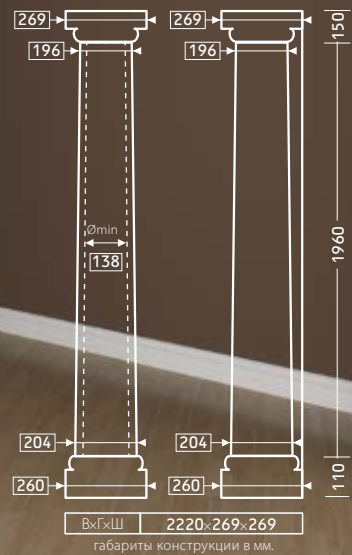
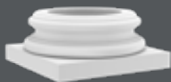

КАПИТЕЛЬ
1.11.002

СТВОЛ
1.12.020



БАЗА
1.13.100

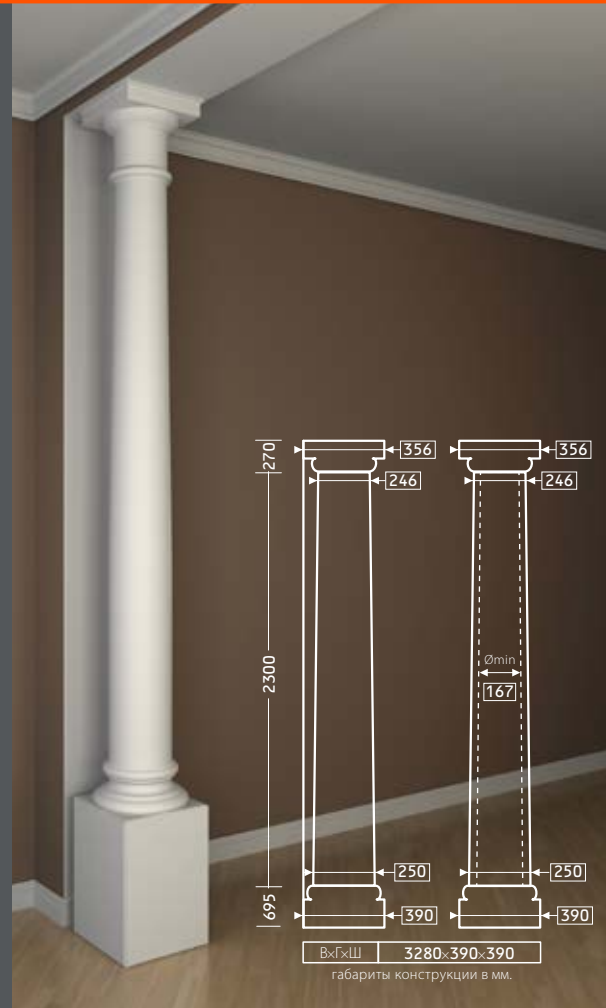
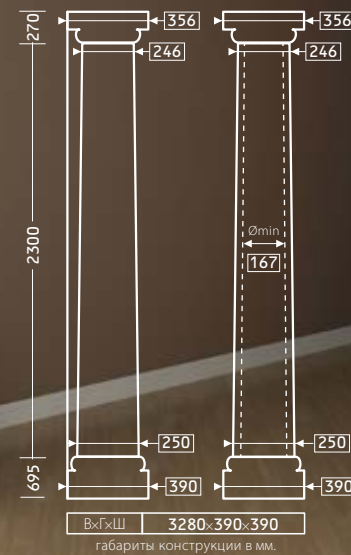

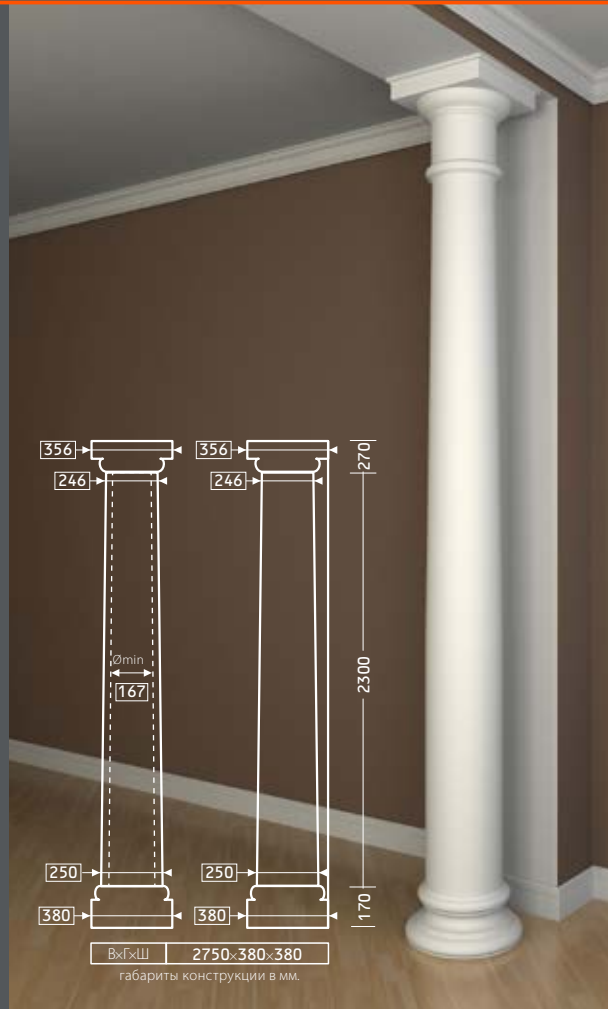
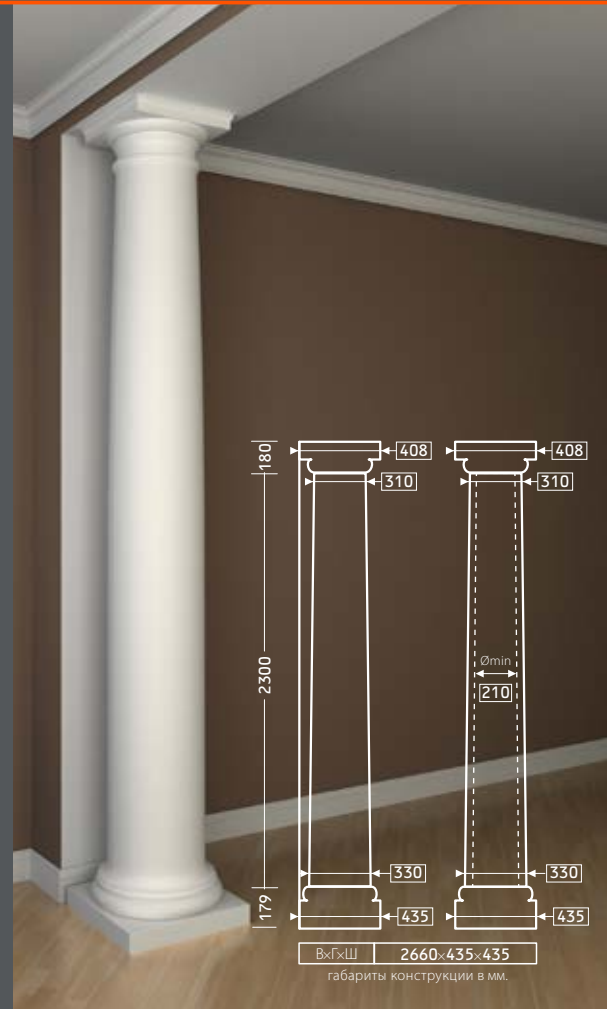
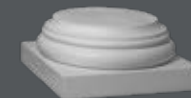
КАПИТЕЛЬ
1.11.002СТВОЛ
1.12.020БАЗА
1.13.200КАПИТЕЛЬ
4.11.101СТВОЛ
4.12.101БАЗА
4.13.101

КАПИТЕЛЬ 4.11.101 СТВОЛ 4.12.102



БАЗА 4.13.101

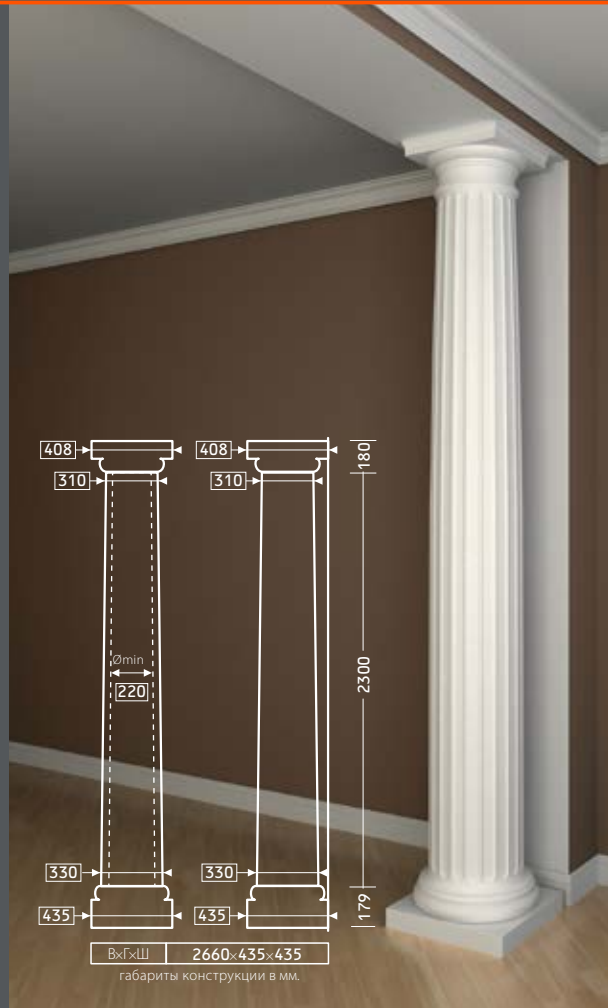
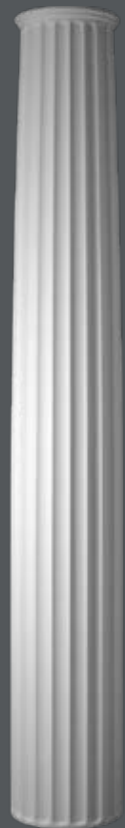
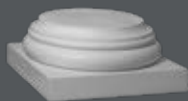

КАПИТЕЛЬ 4.11.102 СТВОЛ 4.12.001



БАЗА 4.13.001

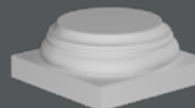

СТВОЛ 4.12.002

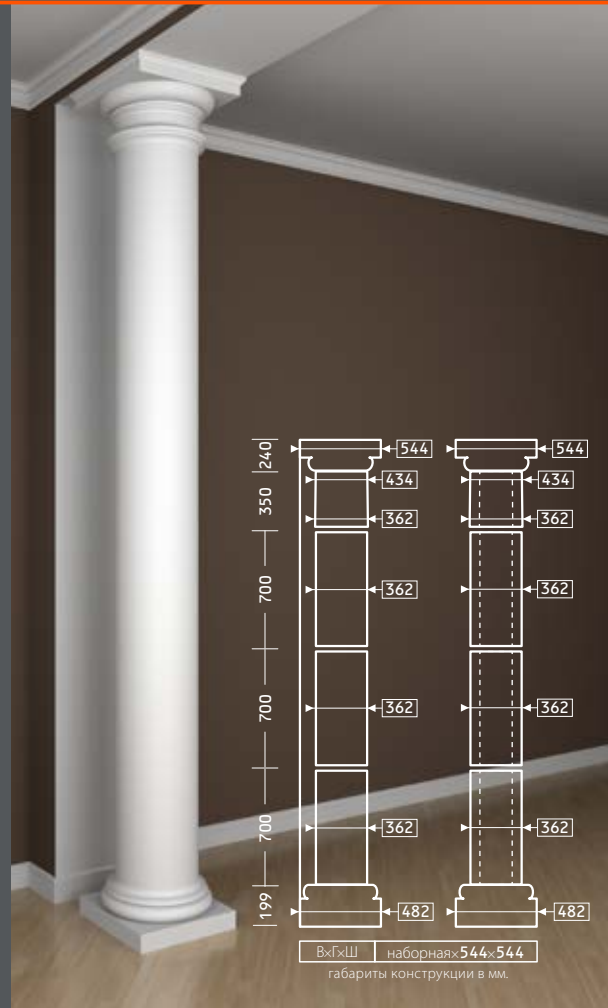

КАПИТЕЛЬ
4.11.102



СТВОЛ
4.12.003



БАЗА
4.13.001

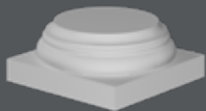

СТВОЛ
4.12.004



СТВОЛ
4.12.005

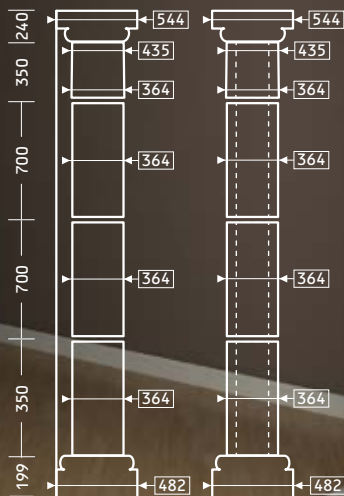
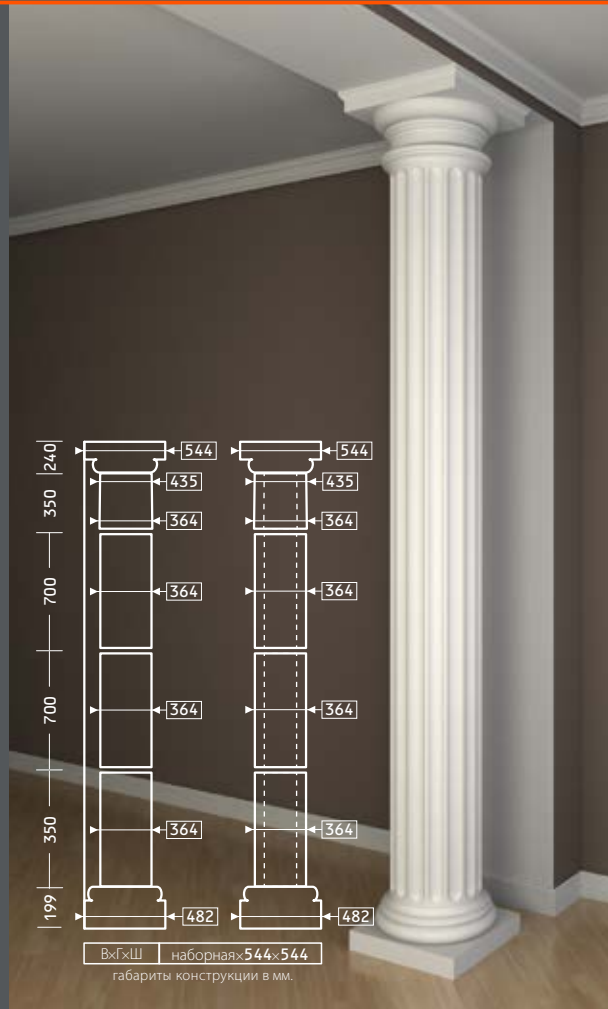

ВхГхШ наборная 544х544
габариты конструкции в мм.





ОБРАМЛЕНИЯ
АРК
И ДВЕРЕЙ

1.54.002

96 × 30 × 96



1.54.013

109 × 28 × 109



1.54.017

86 × 27 × 86



1.54.004

235 × 26 × 2080



1.54.012

115 × 10 × 730



1.51.307

96 × 25 × 2000



1.54.030

230 × 29 × 109



1.54.009

115 × 10 × 310



1.54.019

115 × 10 × 310

1.54.004

235 × 26 × 2080



1.54.007 1.54.008 1.54.013

115 × 11 × 156 115 × 15 × 153 109 × 28 × 109



1.54.001

98 × 30 × 98



1.54.017

86 × 27 × 86



1.54.010

250 × 31 × 95



1.51.307

96 × 25 × 2000



1.54.009
115 × 10 × 310



1.54.004
235 × 26 × 2080



1.54.007 1.54.008 1.54.013
115 × 11 × 156 115 × 15 × 153 109 × 28 × 109



1.54.001
98 × 30 × 98



1.54.017
86 × 27 × 86



1.54.030
230 × 29 × 109



1.51.307
96 × 25 × 2000



1.54.002

96 × 30 × 96



1.54.013

109 × 28 × 109



1.54.017

86 × 27 × 86



1.54.005

140 × 15 × 330



1.51.307

96 × 25 × 2000



1.54.004

235 × 26 × 2080



1.54.030

230 × 29 × 109



1.55.003

53 × 43 × 134



1.55.002

320 × 26 × 650



1.55.001

320 × 26 × 650



1.55.005

126 × 41 × 95



1.51.307

96 × 25 × 2000



1.55.004

50 × 43 × 231



1.54.010

250 × 31 × 95



1.54.020

250 × 31 × 95



1.63.001

146 × 57 × 1280



1.63.002

146 × 57 × 1280



1.63.003

230 × 38 × 920



1.51.307

96 × 25 × 2000



1.54.030

230 × 29 × 109



1.54.002

96 × 30 × 96



1.54.013

109 × 28 × 109



1.54.017

86 × 27 × 86



1.54.004

235 × 26 × 2080



1.54.011

113 × 15 × 435



1.51.310

96 × 19 × 2000

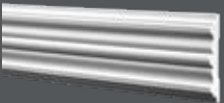

1.54.020

250 × 31 × 95

