



QRZ?

LOWBANDSYSTEMS.COM

RA6LBS - ANDREI

• **CTU** •
CONTEST
UNIVERSITY



Centro Fiera del Garda
Montichiari (Bs)

SISTEMI DI ANTENNE

RICEVENTI



Centro Fiera del Garda
Montichiari (Bs)

**PERCHÉ
ABBIAMO
BISOGNO?**

- **BECAUSE OF THE NOISE ON 160÷40!**
- **YOU CAN TRANSMIT WITH GREAT SUCCESS ON VERTICAL, EVEN ON DIPOLE ...**

**BUT IF YOU CAN NOT RECEIVE
EVERYONE WHO IS CALLING YOU ...**

YOUR ARE AN

ALLIGATOR!

COCCODRILLO!



Centro Fiera del Garda
Montichiari (Bs)

PERCHÉ ABBIAMO BISOGNO?

- **YOUR TX ANTENNA HAS TO DELIVER STRONGEST SIGNAL**
- **EFFICIENCY IS NEEDED**

- **BUT RX ANTENNA HAS TO IMPROVE SIGNAL TO NOISE RATIO ONLY**
- **TO SOME DEGREE GAIN/EFFICIENCY IS NOT A BIG DEAL**

ANTENNE RICEVENTI :

- **KEY TO SUCCESS IN DXING,
CONTESTING**
- **MUCH LESS EXPENSIVE COMPARE
TO TRANSMIT ANTENNAS**
- **YES, REQUIRES SOME REAL ESTATE,
KNOWLEDGE , EFFORTS AND BUGET**



Centro Fiera del Garda
Montichiari (Bs)

ANTENNE RICEVENTI

- **COSA STANNO
COMBATTENDO?**



Centro Fiera del Garda
Montichiari (Bs)

ANTENNE RICEVENTI

REDUCING:

- **QRN:**
 - **IMPROVING SIGNAL TO NOISE RATIO BY USING DIRECTIONAL PATTERN**
- **QRM:**
 - **NULLING UNWANTED DIRECTIONS – STATIONS WHO IS STRONGER THEN DX**

NOISE SOURCES:

- LOCAL

**IS WHAT AFFECTS
YOUR ABILITY TO
HEAR WELL**

- PROPAGATED

- EVEN COSMIC



Centro Fiera del Garda
Montichiari (Bs)

NOISE :

**LEARN YOUR QTH NOISE
PATTERN,
HOW DOES IT CHANGE
DURING NIGHTS AND
SEASONS**

**NOWADAYS SDR
RADIOS MAKES
MEASUREMENTS
MUCH EASIER AND
INFORMATIVE**



Centro Fiera del Garda
Montichiari (Bs)

NOISE:

LOCAL SOURCES

HOME APPLIANCES LIKE:

- **POWER SUPPLIES**
- **LED LIGHTS**
- **POMPE**
- **COOLING AND HEATING SYSTEMS**
- **POWER POLES WITH LEAKING INSULATORS**
- **ANYTHING WHAT CAN APPEAR IN A CASA VICINA**

CAN BE AS FAR AS FEW KILOMETERS AWAY!

DIVERSE PROPRIETÀ DELL'ANTENNA

- **RADIATION PATTERN IN A VERTICAL AND HORIZONTAL PLANE**
- **GAIN, (NEGATIVE)**
- **RDF - MEASURE OF PROPERTIES (PARTIALLY USEFUL), SOMETHING IN THE RANGE OF 4÷15DB**
- **SENSITIVITY TO OTHER ANTENNAS, METAL STRUCTURES**
- **POLARIZATION**

NOISE:

LOCAL SOURCES

WHAT TO DO?



Centro Fiera del Garda
Montichiari (Bs)

NOISE:

LOCAL SOURCES

FORZA!



Centro Fiera del Garda
Montichiari (Bs)

NOISE:

LOCAL SOURCES

**FIND A
SOURCE FIRST**

**REPLACE OR
REPAIR**



Centro Fiera del Garda
Montichiari (Bs)

NOISE:

SKY WAVE PROPAGATED SIGNALS

- **NATURAL ATMOSPHERIC, PROPAGATED WITH DARKNESS, DISTANT THUNDERSTORMS ETC.**
- **NOT EQUALLY DISTRIBUTED FROM DIRECTIONS!**
- **COMING AT THE DIFFERENT ARRIVAL ANGLES AT SUNSET, MIDNIGHT AND SUNRISE!**
- **NOISE AT EQUATOR IS A VERY SPECIAL CASE**
- **NOISE IS ALMOST ABSENT OVER THE POLAR CIRCLE**

NOISE:

**SKYWAVE
PROPAGATED
SIGNALS**

WHAT TO DO?



Centro Fiera del Garda
Montichiari (Bs)

NOISE:

**SKYWAVE
PROPAGATED
SIGNALS**

**BUILD
ANTENNAS
WITH
DIRECTIVITY!**



Centro Fiera del Garda
Montichiari (Bs)

HOW TO CHOOSE RECEIVE ANTENNA?



Centro Fiera del Garda
Montichiari (Bs)

ANTENNE RICEVENTI:

- **YOU WILL NEVER HAVE
ENOUGH NUMBER OF RECEIVE
ANTENNAS !**

- **BEST ANTENNA
DOESN'T EXIST !**



Centro Fiera del Garda
Montichiari (Bs)

ANTENNE RICEVENTI:

**ESPERIENZA DI
APPRENDIMENTO
DIFFICILE**

- **YOU NEED ANTENNAS:**

- **TO DIFFERENT DIRECTIONS**
- **WITH DIFFERENT VERTICAL PATTERN**
- **WITH DIFFERENT HORIZONTAL PATTERN:**
NOT ONLY SHARP, BUT WIDE ALSO



Centro Fiera del Garda
Montichiari (Bs)

ANTENNE RICEVENTI :

PROPAGATION FACTOR

- **IT IS NECESSARY TO COUNT ON ARRIVAL ANGLE OF INCOMING SIGNAL**
- **AND ARRIVAL ANGLE IS DIFFERENT AT DIFFERENT TIME OF THE NIGHT**

ANTENNE RICEVENTI:

PROPAGATION FACTORS

BEFORE AND RIGHT AFTER **THE SUNSET, MOST
OFTEN ARRIVAL ANGLES IS VERY LOW FROM EAST
AT OUR LATITUDES**

**ONLY THOSE OF US WHO HAD TRIED TO
SWITCH BEVERAGE LENGTH BETWEEN
300 / 600 / 1000 METERS ON THE SAME
STATION, AT THE SAME TIME
KNOWS HOW AMAZINGLY IT WORKS!**

**MAIN REASON FOR BETTER RECEPTION IS CHANGE
OF VERTICAL ANGLE, NOT THE BEAM WIDE CHANGE**

**WE NEED LOWER ANGLE ANTENNA TO
THE EAST AT SUNSET!**



Centro Fiera del Garda
Montichiari (Bs)

ANTENNE RICEVENTI:

PROPAGATION FACTOR

QUITE A DIFFERENT STORY **ON SUNRISE:**

AT THE DAWN, MOST OFTEN WE NEED HIGHER
ARRIVAL ANGLE ANTENNA TO THE WEST

VERY OFTEN LOW DIPOLE, INVERTED VEE
*(ANTENNAS WITH A HIGHER VERTICAL
PLANE)*, WILL OUTPERFORM PRETTY GOOD
BEVERAGE AT THE DAWN AND AFTER

YOU MUST TRY DIFFERENT ANTENNAS, NOT
ONLY THE ONE YOU LIKED AT MIDNIGHT!



Centro Fiera del Garda
Montichiari (Bs)

**È ANCHE
IMPORTANTE DA
RICORDARE**

**ESPERIENZA DI
APPRENDIMENTO
DIFFICILE**

- **POLAR PATH IS SKEWED**
- **DIFFICULT, LONG DISTANCE PATH,
(PACIFIC) MAY BE HEARD FROM AS
MUCH AS 30÷45 DEGREE SKEWED
DIRECTION**
- **MAGNET DECLINATION CAN BE
SURPRISINGLY BIG IF YOU ARE IN A
DXPEDITION OUTSIDE OF EU. CHECK IT
BEFORE PUTTING ANTENNAS IN THE
FIELD!**
 - **USE A RIGHT TOOL TO AIM YOUR
ANTENNA!**



Centro Fiera del Garda
Montichiari (Bs)

US/UK World Magnetic Model - Epoch 2015.0

Main Field Declination (D)

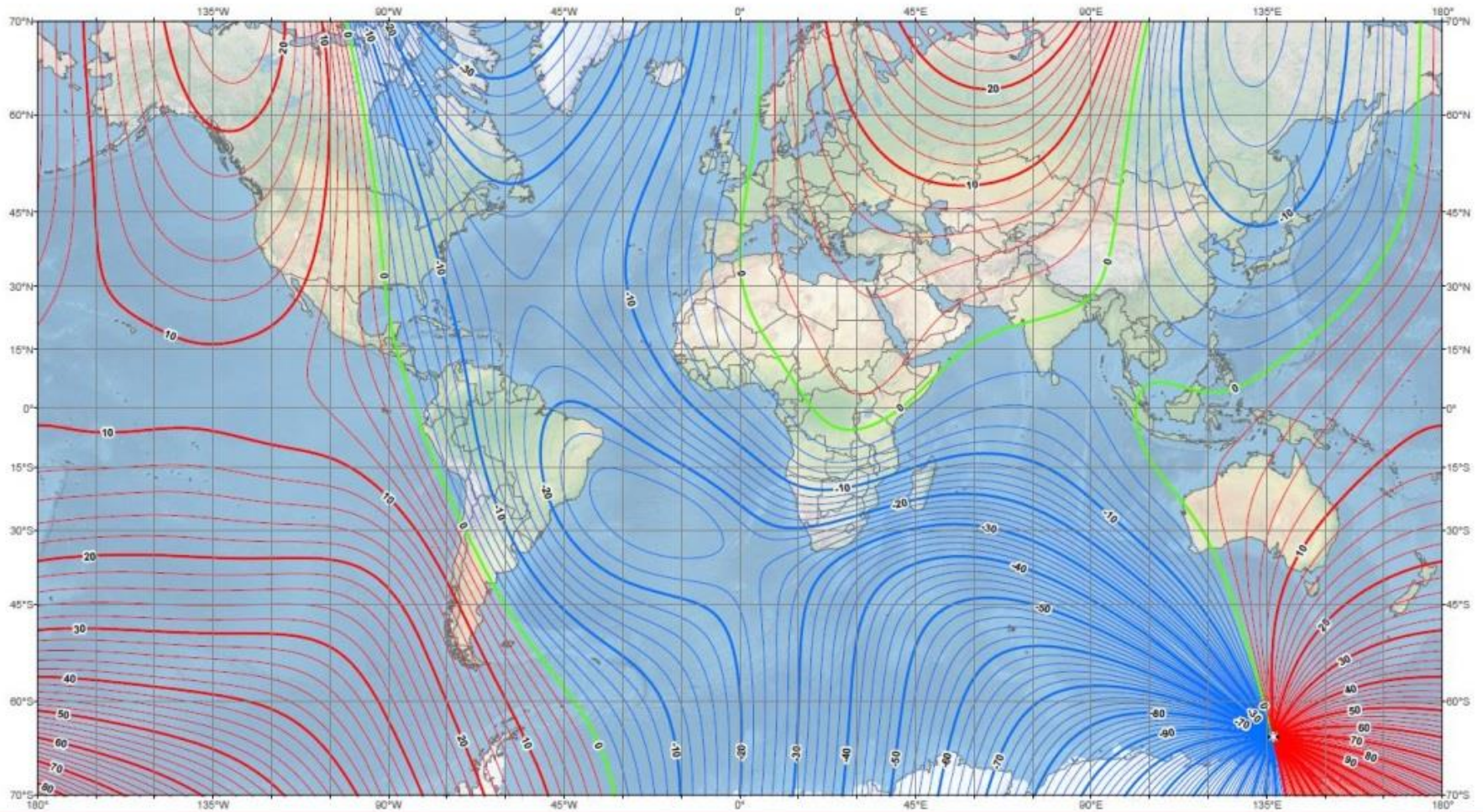

IF YOU HAVE RECEIVE ANTENNAS, YOU SHOULD TAKE CARE OFF:

DECOUPLING YOUR RX ANTENNA FROM:

- TRANSMIT ANTENNAS
- TOWERS
- FEEDLINES
- POWER LINES



Centro Fiera del Garda
Montichiari (Bs)

DECOUPLING:

**GENERAL RULE OF THUMB IS THAT AT LEAST
1-2 WAVELENGTH OF CLEAR SPACE IS NEEDED
AROUND RECEIVE ANTENNA**

**OTHERWISE IT`S MODELED PATTERN WILL BE
AFFECTED WITH INFLUENCE OF RERADIATION
FROM ANTENNAS, TOWERS, GUY WIRES,
FEEDLINES POWER LINES ETC.**

CACTUS, CESPUGLI E ALBERI ARE OK



Centro Fiera del Garda
Montichiari (Bs)

**CHE TIPO DI
ANTENNA È
NECESSARIA?**

FOR DX'ING?

- **COMFORTABLE BLA-BLA-BLA WITH EU?**

LOOP?

- **WORK SOME NEW ONES AND DX (NOW YOU
HAVE #73 DXCC COUNTRIES CFM)?**

2X2 DIRECTION LOOPS?

- **TO PUT INTO THE LOG THE VERY LAST DXCC
ENTITY ON 160?**

LONG BEVERAGE?

- **TO WORK SOME QUITE RARE DX PEDITION
FROM PACIFIC OR ASIA?**

2-3 LONG BEVERAGES?



Centro Fiera del Garda
Montichiari (Bs)

**CHE TIPO DI
ANTENNA È
NECESSARIA?**

**FOR
CONTESTING?**

- **TO WIN EU IN A WW160SSB
CONTEST?**

12 LONG BEVERAGES?

- **TO WORK 3RD LAYER OF US 100W
STATION IN WW160CW?**

4 X LONG BEVERAGES STACK?

- **TO RUN INBAND ON 160?**

**MANY PHASED ARRAYS AND GOOD
ENGINEERING?**



Centro Fiera del Garda
Montichiari (Bs)

**COSA TI
SERVE A TE?**

QUESTI SONO SISTEMI DIVERSI !



Centro Fiera del Garda
Montichiari (Bs)

VARIETÀ DI RECEVENTI ANTENNE

- **OCUPYING A SMALL SPACE**
- **OCUPYING A BIG SPACE**
- **ALTE ANTENNE**
- **ANTENNE QUASI INVISIBILI MA EFFICACE**

VARIETÀ DI RECEVENTI ANTENNE

SISTEMA SINGOLA DI DIREZIONE:

- COSTITUITI DA ELEMENTI (1÷6) A
BEVERAGE
- COSTITUITI DA ELEMENTI (1÷8) A
LOOP
- COSTITUITI DA ELEMENTI A (1÷8)
VERTICALI

VARIETÀ DI RECEVENTI ANTENNE

SISTEMI MULTI DIREZIONALE:

- COSTITUITI DA ELEMENTI **VERTICALI**
[3÷8]:
 - **MULTIBANDA** - HIGH IMPEDANCE SYSTEMS (WIDEBAND PREAMPS CAN BE A PROBLEM)
 - **MONOBANDA** - LOW IMPEDANCE SYSTEMS
- COSTITUITI DA ELEMENTI A **LOOP**
[2÷16]
- COSTITUITI DA ELEMENTI A **BEVERAGE**
(NON LIMITATO)

VARIETÀ DI RECEVENTI ANTENNE

ANTENNE ROTANTI PER 160-80:

- **WALLER FLAG**
 - **HORIZONTAL AND VERTICAL POLARIZATION**
 - **30 METERS MINIMUM TOWER HEIGHT**
 - **HEAVY DECOUPLING OF ANYTHING NEARBY**

STORIA DELL ANTENNE RICEVENTI

**MOST OF THE ANTENNAS USED
NOWADAYS WAS DEVELOPED LAST
CENTURY, PRE WORLD WAR II FOR
MILITARIES**

**BEVERAGES, TERMINATED LOOPS AND
VERTICALS IN ALL OF ITS VARIANTS IS
BASIC BRICKS OF TODAYS RECEIVE
ARRAY TECHNOLOGIES**



Centro Fiera del Garda
Montichiari (Bs)

ANTENNE RICEVENTI

LAST CENTURY PATENTS:

BEVERAGE

100 YAERS TO BE MARKED
PRETTY SOON!



H. H. BEVERAGE.
RADIORECEIVING SYSTEM.
APPLICATION FILED APR. 10, 1920.

1,381,089.

Patented June 7, 1921.

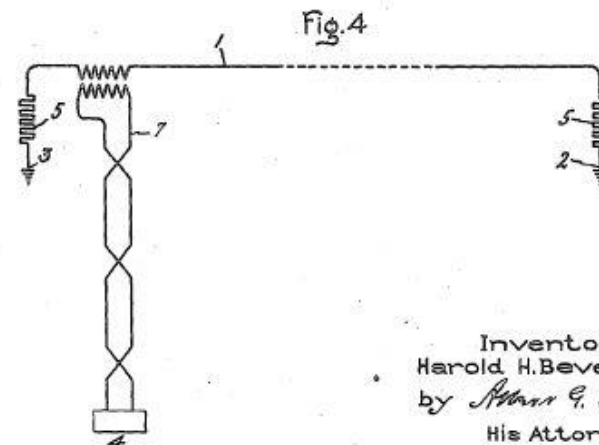
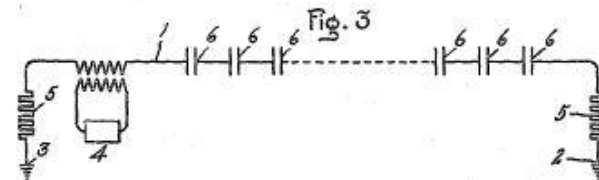
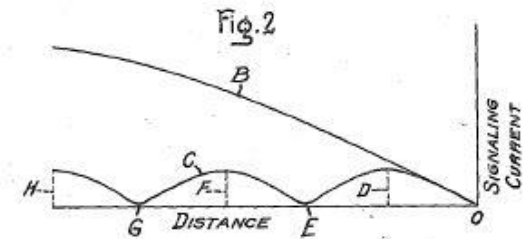
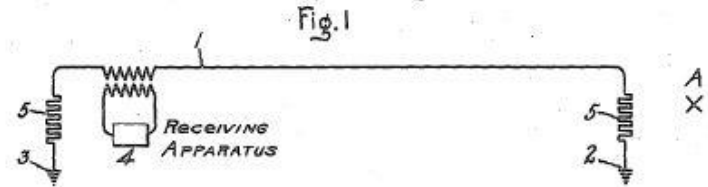

Inventor:
Harold H. Beverage,
by *Arthur G. Davis*
His Attorney.

ANTENNE RICEVENTI

LAST CENTURY PATENTS:

TERMINATED LOOP BY MR BEVERAGE!



July 1, 1941.

H. H. BEVERAGE

2,247,743

ANTENNA

Filed Dec. 10, 1938

Fig. 1

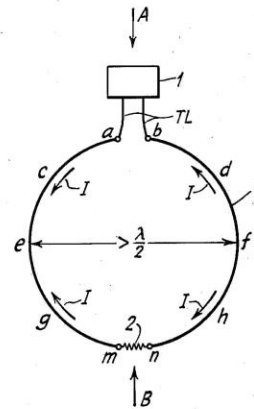

Fig. 2

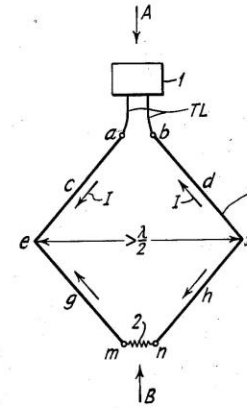

Fig. 3

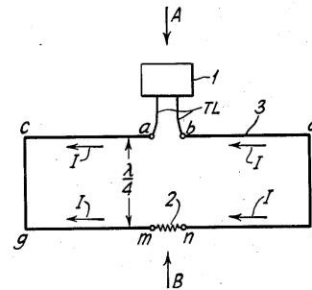
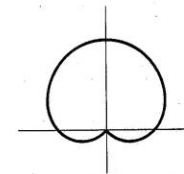

Fig. 4



INVENTOR.
HAROLD H. BEVERAGE
BY *H.S. Snover*
ATTORNEY.

ANTENNE RICEVENTI

BEVERAGE TODAY:

- **CLASSICA SINGOLO FILO**
- **BEVERAGE A TERRA (BOG)**
- **BI – DIREZIONALE CON 2 FILI**
- **BI – DIREZIONALE CON CAVO COASSIALE**
- **BI – DIREZIONALE A TERRA (BOG)**
- **SINGOLA USHITA, DOPPIA USHITA**



Centro Fiera del Garda
Montichiari (Bs)

ANTENNE RICEVENTI

BEVERAGE:

- CLASSICA SINGOLO FILO
- BEVERAGE A TERRA (BOG)



ANTENNE RICEVENTI

BEVERAGE:

- BI – DIREZIONALE CON CAVO COASSIALE
- BI – DIREZIONALE CON CAVO COASSIALE
TERRA (BOG)



ANTENNE RICEVENTI

BEVERAGE:

- **BI – DIREZIONALE CON 2 FILI**



ANTENNE RICEVENTI

BEVERAGE:

- **BI – DIREZIONALE CON CON CAVO
COASSIALE E DOPPIA USCITA**



ANTENNE RICEVENTI

SYSTEMI IN FASE :

COMBINA LE USCITA DI PIU E ANTENNE :

- AUMENTA USCITA DI ANTENNE
- MIGLIORE PERFORMANCE

■ COSTITUITI DA ELEMENTI A **BEVERAGE**

■ COSTITUITI DA ELEMENTI **VERTICALI**

■ COSTITUITI DA ELEMENTI A **LOOP**



Centro Fiera del Garda
Montichiari (Bs)

ANTENNE RICEVENTI

**BEVERAGE ARRAYS,
SINGOLE/MULTIPLE
DIREZIONI**

- **BROADSIDE**
- **STAGGERED**
- **A PAIR AT DIFFERENT
DIRECTION AND COMBINED
WITH/WITHOUT PHASE SHIFT**
- **DESIGNED, PATENTED LAST
CENTURY ALSO**



Centro Fiera del Garda
Montichiari (Bs)

ANTENNE RICEVENTI

**3 X 2BV STAGGERED, 320 M.
TO US**

**BEVERAGE ARRAYS,
SINGOLE/MULTIPLE
DIREZIONI**

**ELECTRYCALLY ROTABLE
PATTERN TO COMPENSATE
SKEWING**



Centro Fiera del Garda
Montichiari (Bs)

ANTENNE RICEVENTI

4 SQUARE ARRAY
4 DIREZIONI

- **COSTITUITI DA ELEMENTI VERTICALI**
 - **RISONANTI A LARGA BANDA**
- **COSTITUITI DA ELEMENTI A LOOP**
 - **LARGA BANDA**
- **A PICCOLA DIMENSIONE A 20 X 20 METRI**
- **DIFFERENZA DI FASE E DI SCHEMA**

ANTENNE RICEVENTI

4 SQUARE ARRAY

**COSTRUITI DA ELEMENTI
VERTICALI**

4 DIREZIONI

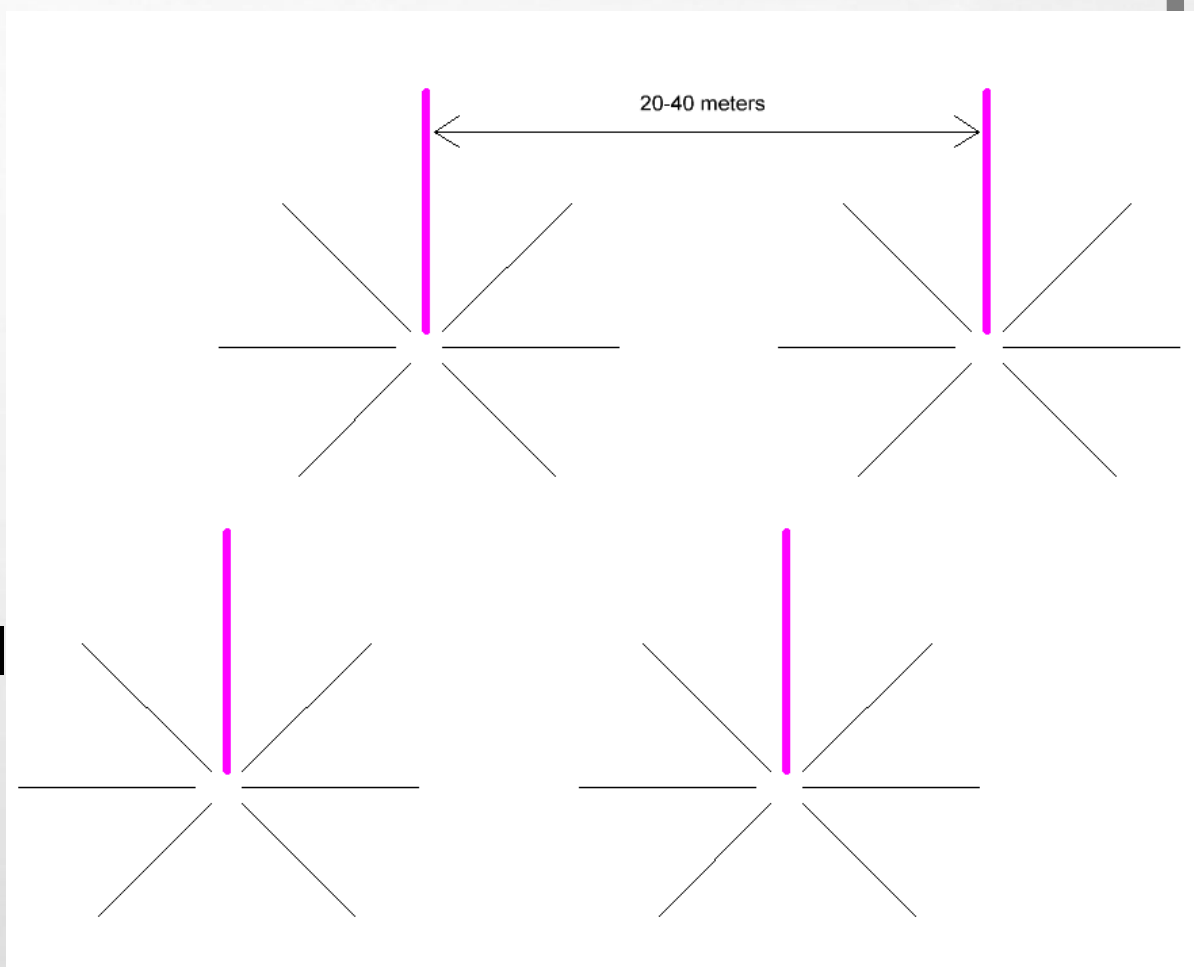

ANTENNE RICEVENTI

4 SQUARE ARRAY

**COSTRUITI DA ELEMENTI
VERTICALI**

4 DIREZIONI

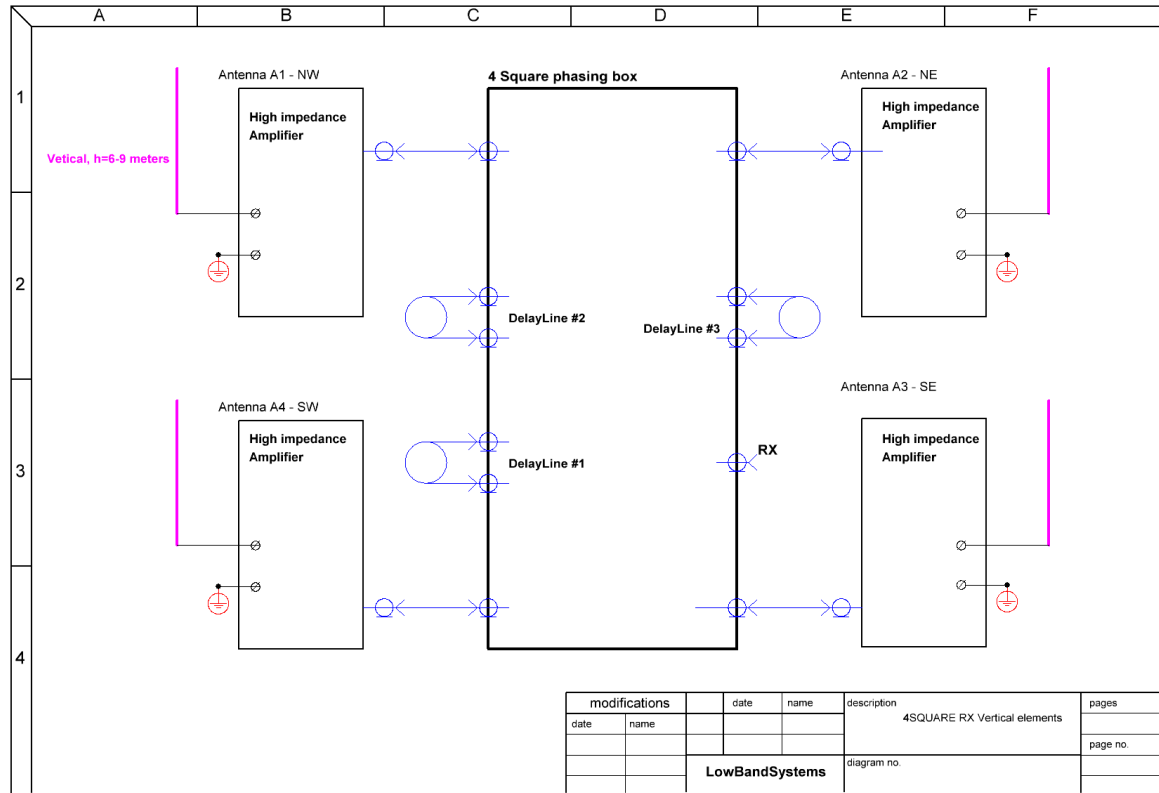

Centro Fiera del Garda
Montichiari (Bs)

4 SQUARE ARRAY

**COSTRUITI DA 8
ELEMENTI LOOP**

**4 DIREZIONI,
CON MIGLIORAMENTI
DI AVANTI E INDIETRO
F/B, F/S**

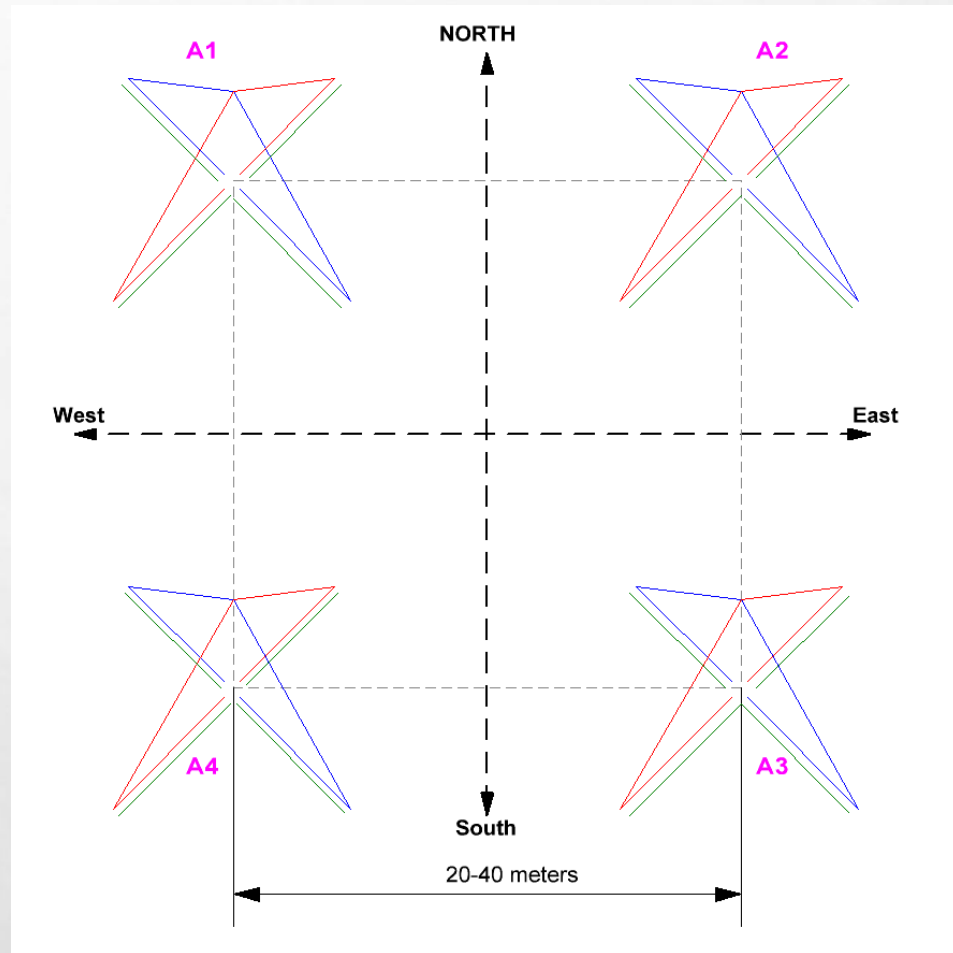

4 SQUARE ARRAY

**COSTRUITI DA 8
ELEMENTI LOOP**

**4 DIREZIONI,
CON MIGLIORAMENTI
DI AVANTI E INDIETRO
F/B, F/S**

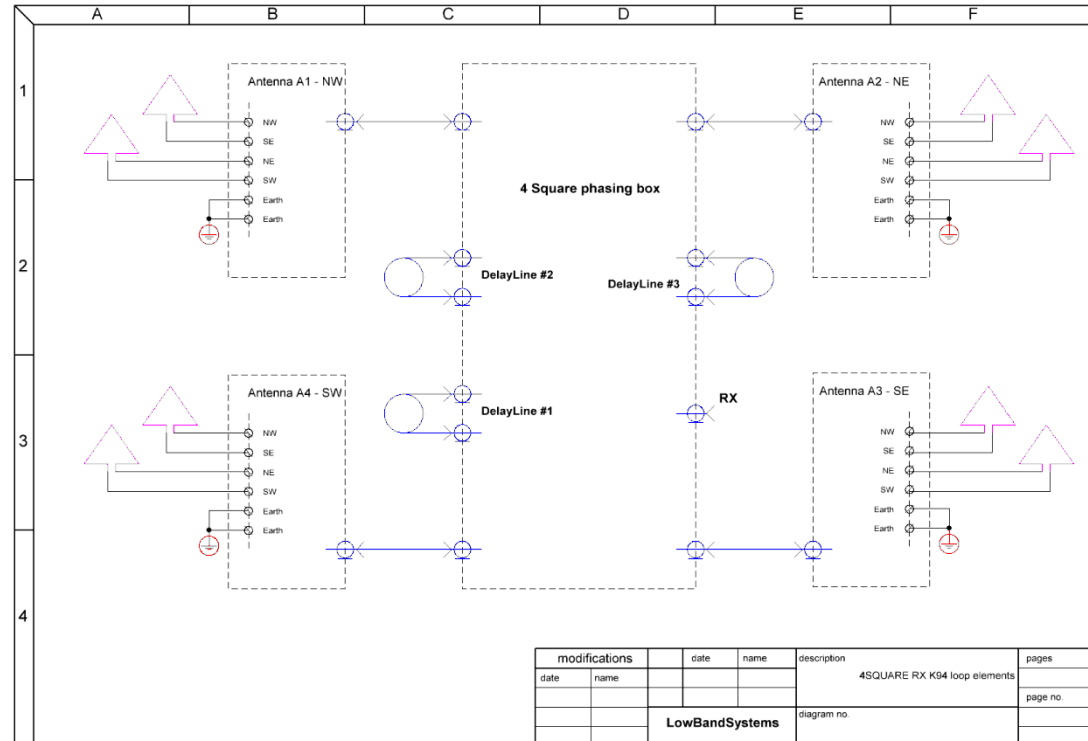



4 SQUARE ARRAY

**COSTRUITI DA 8 ELEMENTI
LOOP**



ANTENNE RICEVENTI

4 SQUARE ARRAY

**COSTRUITI DA 8
ELEMENTI LOOP**

- **CHECK YOUTUBE VIDEOS
BY UROMC HOW IT
WORKS**



Centro Fiera del Garda
Montichiari (Bs)

ANTENNE RICEVENTI

8 CIRCLES:

8 DIREZIONI ,

CON MIGLIORAMENTI DI
AVANTI E INDIETRO F/B, F/S

- COSTITUITI DA ELEMENTI **VERTICALI**
- COSTITUITI DA ELEMENTI A **LOOP**
 - 60÷100 METRI DI DIAMETRO ROTONDO
- **DIFFERENTE FASI E SCHEMA:**
 - **BSEF**
 - **HI-Z SYSTEM**



Centro Fiera del Garda
Montichiari (Bs)

ANTENNE RICEVENTI

8 CIRCLES:

8 DIRIEZIONE,

DI ANTENNE VERTICALI

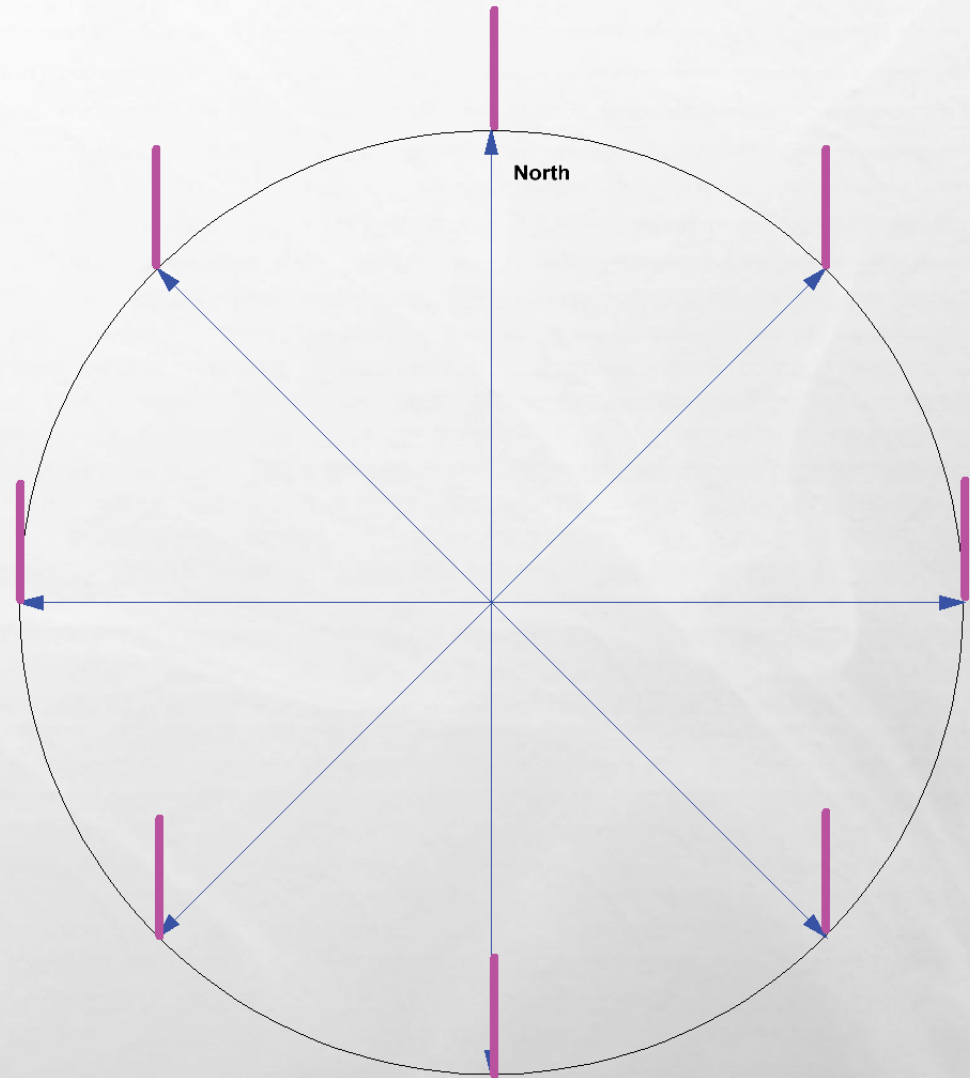

ANTENNE RICEVENTI

8 CIRCLES:

**8 DIRIEZIONE,
DI ANTENNE**

LOOP K-98

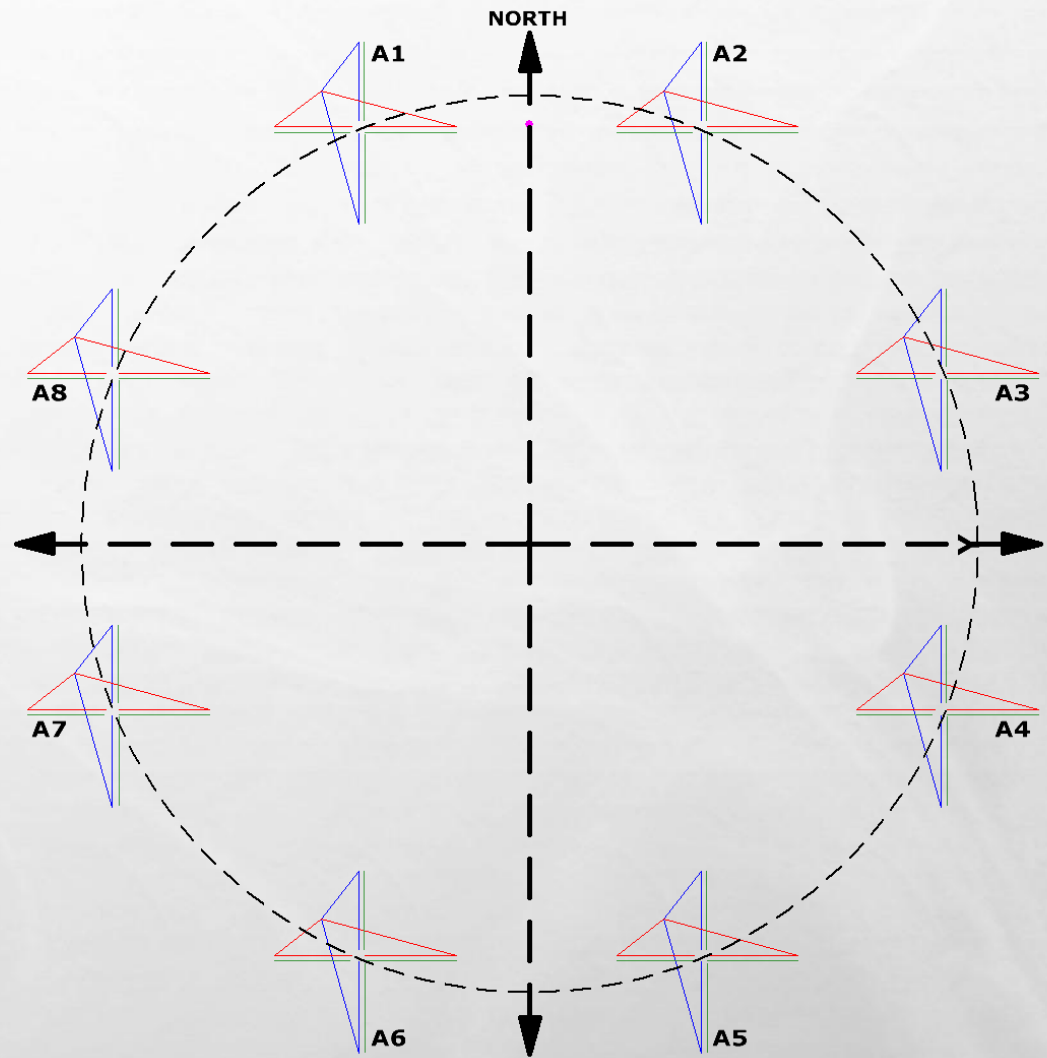

COSA TI SERVE:

- **REMOTE RELAY SWITCH**

DISTRIBUTION SYSTEM FOR S02R, M/S, MM

- **CONTROL CONSOLE**

- **BAND PASS FILTERS**

MUST FOR FOR S02R, M/S, MM)

- **PREAMPLIFIERS**

- **SOME KIND OF PROTECTION OFF
YOUR OWN SIGNAL**

- **PROTECTION AGAINST LIGHTNING**



Centro Fiera del Garda
Montichiari (Bs)

**SE TU HAI ANTENNE
RICEVENTE**

FAI QUESTO:

ISOLATION IN A SWITCHING SYSTEMS

- **OF DIFFERENT RECEIVE ANTENNA
SWITCHES**
- **TRANSMIT / RECEIVE ANTENNAS
SWITCH IN A RIG**

**SE TU HAI ANTENNE
RICEVENTE**

ISOLATION IN A SWITCHING SYSTEMS !

FAI QUESTO:

- **PROBLEM EXISTS BETWEEN A RELAY SWITCH ISOLATION AND DIRECTIVE ANTENNA F/S F/B**
- **RELAYS ISOLATION IS IN -50DB RANGE**
- **F/B AND F/S IS ON ORDER OF -30DB**
- **LOOKS LIKE WE HAVE A SAFETY MARGIN OF 20DB ...**



Centro Fiera del Garda
Montichiari (Bs)

SE TU HAI ANTENNE RICEVENTE

REMEMBER:

**DIFFERENT RX ANTENNAS HAS DIFFERENT
OUTPUT LEVELS, IT CAN BE 20DB!**

**TX ANTENNAS HAS OUTPUT LEVEL OF
+20DB TO A AN AVAREGE RX ANTENNA!**

**THIS “EXTRAS” UP TO 40DB CAN DESTROY
AL OF YOUR NICE ANTENNA PROPERTIES**



Centro Fiera del Garda
Montichiari (Bs)

PREAMPLIFICATORE SEMPLICE

FILTRO PASSA ALTO

ANCHE PER SINGOLA BANDA BPF

- **75 O 50 OHME SYSTEMA**
- **CONNETTORI UHF O F**
- **+12DB OR +18DB**
- **15VDC VIA COAX**
O SU LINEA SEPARATA



CONTROLLO PER

PREAMPLIFICATORE SEMPLICE

- **75 O 50 OHME SYSTEMA**
- **CONNETTORI UHF O F**
- **15VDC VIA COAX**



Centro Fiera del Garda
Montichiari (Bs)

COMMUTATORE D'ANTENNA CON FILTRO PASSA ALTRO E PREAMPLIFICATORE

4 INPUTS;

PREAMPLIFICATORE : +18DB;

INPUT STAGES

PROTECTION DURING TX;



COMMUTATORE DI ANTENNE

8 INPUTS;

BCD CONTROLLED DIRECTION SWITCH;

INPUT STAGES PROTECTION DURING TX;

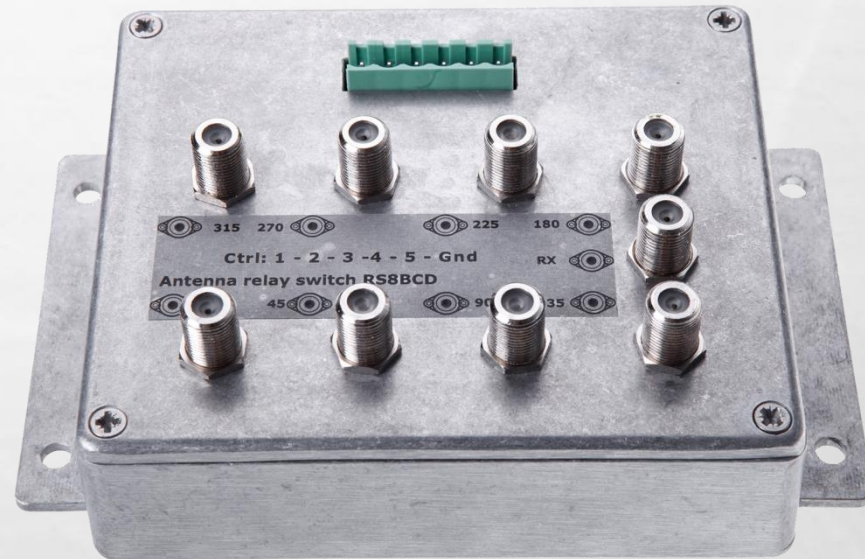

COMMUTATORE D'ANTENNA CON BPF E PREAMPLIFICATORE

8 INPUTS, 75 O 50 OHME SYSTEMA

• CONNETTORI UHF O F;

**BANDPASSFILTERS: 160 - 80 - 40 METERS
BANDS;**

**PREAMPLIFIERS: NORTON DESIGN, 2 X
12DB GAIN;**

INPUT SATGES PROTECTION DURING TX;



CONTROLLER PER PREAMPLIFICATORE CON BPF E PREAMPLIFICATORE

**PULSANTIERE DI CONTROLLO
PERSONALIZZABILI PER:**

**COMMUTATORI D'ANTENNA REMOTI, RX
ARRAYS,**

SISTEMI MULTIPLI DI BEVERAGE, SISTEMI

**DI DISTRIBUZIONE CON FILTRI
PASSABANDA**

E PREAMPLIFICATORI RICEVITORI.



Centro Fiera del Garda
Montichiari (Bs)

CAVO DELL'ANTENNA

- **IN GENERAL CAN BE ANY IMPEDANCE:**

50,75 OR 100 OHMS

IT CAN BE COAX, TWINAX, BIAX

- **75 OHMS IS NOT THE BEST CHOICE ...**
 - **HIGH QUALITY RG6 IS NOT CHEAPER THAN RG8 SERIES**
 - **HIGH QUALITY F CONNECTORS REQUIRES MORE EUROS AND MUST BE ONLY COMPRESSION TYPE**
 - **NEVER EVER USE CCS (BARE COPPER COVERED STEEL CONDUCTOR)**

(-9DB 100 METERS AT 1.8MHZ)
 - **AND RECEIVER IMPEDANCE IS NOT 75 OHMS ...**

FILTRO DI MODO COMUNE

SICURAMENTE NECESSARIO



TRANSFORMER 50/75

FOR
PERFECTIONISTS



Centro Fiera del Garda
Montichiari (Bs)

ALCUNE DOMANDE FREQUENTI

- **MY NEIGHBOR CAN COPY SOME ONE, I DON'T HEAR AT ALL ON MY BEVERAGE!**
 - **100÷200 KM AND PROPAGATION IS DIFFERENT!**
 - **BUILD A BETTER RX ANTENNA!**
 - **WEB SDR?**

- **MY BEVERAGE SWR IS 1:1,7 ON 1950KHZ, HOW CAN I CHANGE IT ?**
 - **BEVERAGE IS NON RESONANT ANTENNA, SHOULD BE MATCHED IN A FREQ RANGE, NOT ON A FREQUENCY OF INTEREST**



Centro Fiera del Garda
Montichiari (Bs)

QUESTIONS? COMMENTS?



Centro Fiera del Garda
Montichiari (Bs)

THANK YOU VERY MUCH FOR YOUR ATTENTION!

**SPASIBO TO STEFANO BRIOSCHI - IK2QEI
FOR INVITATION !**

DE RA6LBS

• **CTU** •
**CONTEST
UNIVERSITY**



Centro Fiera del Garda
Montichiari (Bs)