

Smart Signage User Manual (By Model)

This manual provides information about your Smart Signage including supported types and product specifications per model.

QBN (QB43N QB49N QB55N QB65N QB75N)

QMN (QM43N QM49N QM55N QM65N QM75N QM85N QM98N)

The color and the appearance may differ depending on the product, and the content in the manual is subject to change without prior notice to improve the performance.

Recommended hours of use per day for the QBN models is less than 16 hours.

If the product is used for longer than 16 hours a day, the warranty may be void.

Table of contents

Preparations

Checking the Components	3
Parts	4
Q*43N/Q*49N/Q*55N/Q*65N/Q*75N	4
QM85N	5
QM98N	6
Anti-theft Lock	7
Ports	8
Q*43N/Q*49N/Q*55N/Q*65N/Q*75N	8
QM85N/QM98N	9
Control menu	10
Q*43N/Q*49N/Q*55N/Q*65N/Q*75N/QM98N	10
QM85N	11
Before Installing the Product (Installation Guide)	12
Tilting Angle and Rotation	12
Ventilation	12
Installing the Wall Mount	13
Preparing before installing Wall-Mount	13
Installing the Wall Mount	13
Wall Mount Kit Specifications (VESA)	14

Specifications

General	15
Preset Timing Modes	17

Appendix

License	19
---------	----

Chapter 01

Preparations

Checking the Components

- Contact the vendor where you purchased the product if any components are missing.
- The appearance of the components may differ from the images shown.
- A stand is not provided with the product. To install a stand, you can purchase one separately.
- The RS232C adapter can be used to connect to another monitor using the D-SUB (9-pin) type RS232C cable.

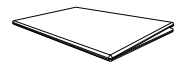

Quick Setup Guide



Warranty card
(Not available in some locations)



Regulatory guide



Power cord

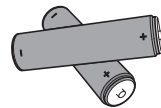

Batteries (AAA x 2)
(Not available in some locations)



Remote Control

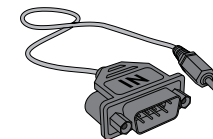

RS232C(IN) adapter



HOLDER-CABLE
(Supported models: Q*65N,
Q*75N, QM85N, QM98N)





Holder-Ring x 4
(Supported models: Q*43N,
Q*49N, Q*55N, Q*65N, Q*75N)

Parts

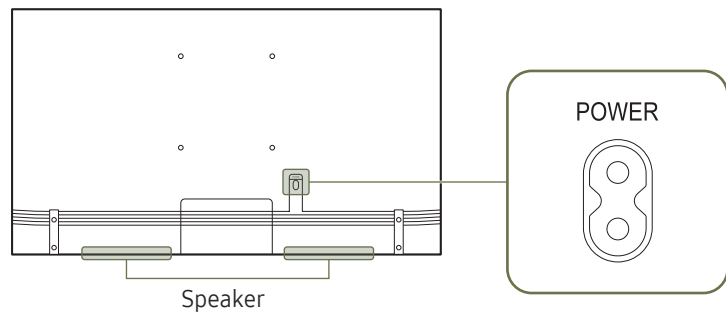
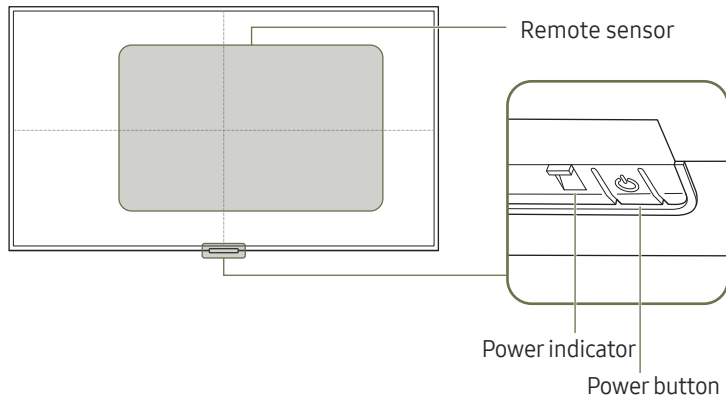



Q*43N/Q*49N/Q*55N/Q*65N/Q*75N



 The color and shape of parts may differ from what is shown. Specifications are subject to change without notice to improve quality.

Parts	Description
Remote sensor	Press a button on the remote control pointing at the sensor on the front of the product to perform the corresponding function.  Using other display devices in the same space as the remote control of this product can cause the other display devices to be inadvertently controlled.
Power button	Turns the product on or off.

Use the remote control within 2.5 m to 4 m from the sensor on the product at an angle of 30° from the left and right.

-  Store used batteries out of reach of children and recycle.
-  Do not use a new and used battery together. Replace both batteries at the same time.
-  Remove batteries when the remote control is not to be used for an extended period of time.
-  To enhance the IR receiver performance, connect an External IR Sensor (sold separately) to the IR IN port.

QM85N

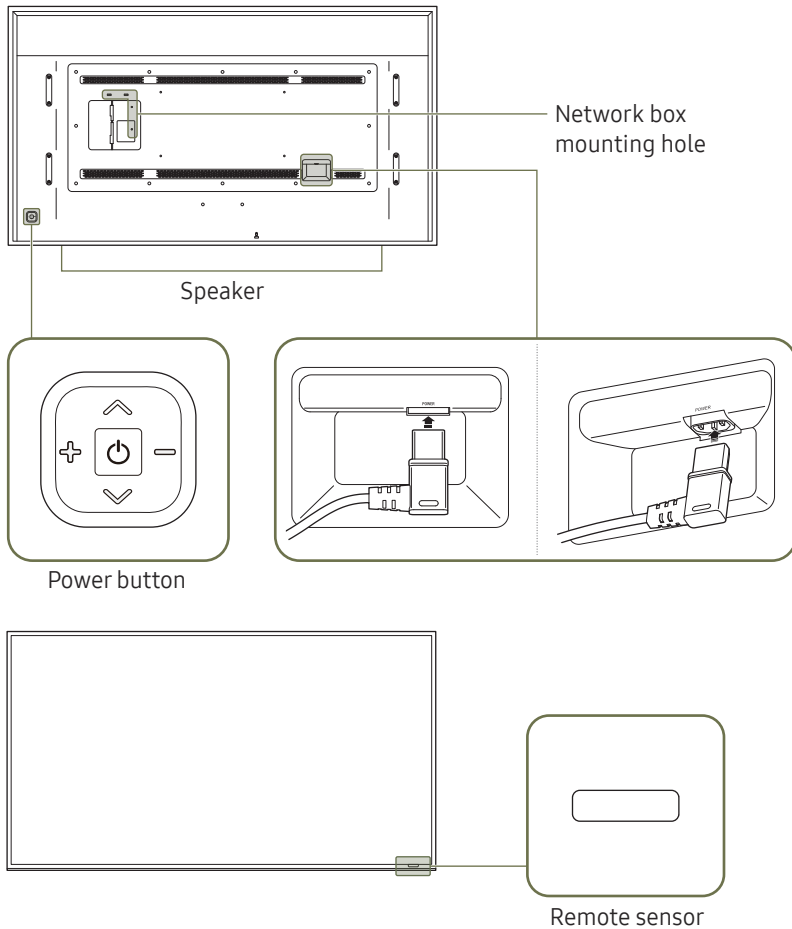

The color and shape of parts may differ from what is shown. Specifications are subject to change without notice to improve quality.

Buttons	Description
	<p>Power on the product.</p> <p>If you press the button when the product is turned on, the control menu will be displayed.</p> <p> To exit the OSD menu, press and hold the button for at least one second.</p>
	<p>Move to the upper or lower menu. You can also adjust the value of an option.</p>
	<p>Move to the left or right menu. You can also adjust the value of an option.</p> <p> You can adjust the volume by moving the power button left or right when the control menu is not displayed.</p>
Remote sensor	<p>Press a button on the remote control pointing at the sensor on the front of the product to perform the corresponding function.</p> <p> Using other display devices in the same space as the remote control of this product can cause the other display devices to be inadvertently controlled.</p>

Use the remote control within 7 m to 10 m from the sensor on the product at an angle of 30° from the left and right.

- Store used batteries out of reach of children and recycle.
- Do not use a new and used battery together. Replace both batteries at the same time.
- Remove batteries when the remote control is not to be used for an extended period of time.
- To enhance the IR receiver performance, connect an External IR Sensor (sold separately) to the IR IN port.

QM98N

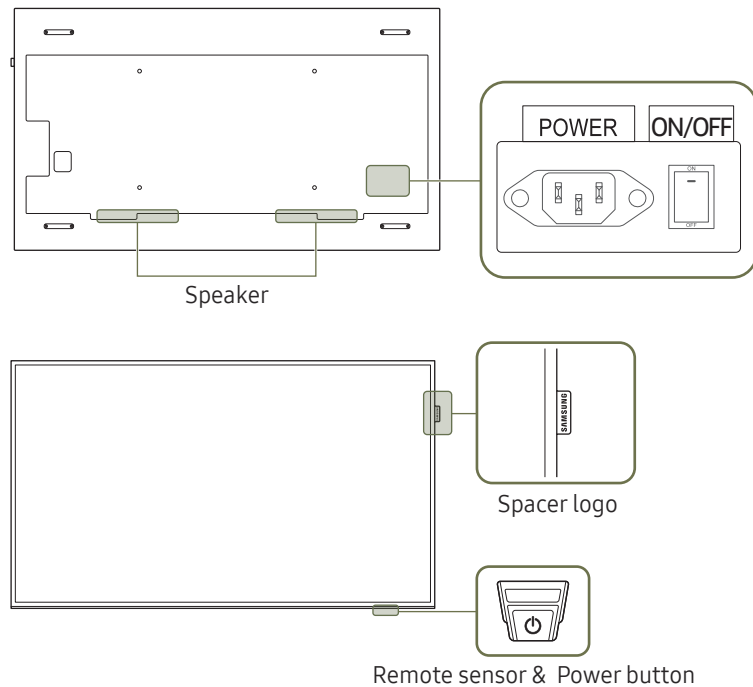





The color and shape of parts may differ from what is shown. Specifications are subject to change without notice to improve quality.

Parts	Description	
Spacer logo	Do not pull on the spacer logo using force. The logo may tear or break off.	
Remote sensor	Press a button on the remote control pointing at the bottom of the product face to perform the function. The remote control sensor is located on the bottom of the product.	
		Using other display devices in the same space as the remote control of this product can cause the other display devices to be inadvertently controlled.
Power button	To use remote/eco sensor, make sure the sliding power button is protruding from the bottom of the product.	
		To use the power button, make sure the sliding power button is not protruding from the bottom of the product.

Use the remote control within 7 m to 10 m from the sensor on the product at an angle of 30° from the left and right.

- Store used batteries out of reach of children and recycle.
- Do not use a new and used battery together. Replace both batteries at the same time.
- Remove batteries when the remote control is not to be used for an extended period of time.
- To enhance the IR receiver performance, connect an External IR Sensor (sold separately) to the IR IN port.

Anti-theft Lock

-  An anti-theft lock allows you to use the product securely even in public places.
-  The locking device shape and locking method depend on the manufacturer. Refer to the user guide provided with your anti-theft locking device for details.
-  The following images are for reference only. Real-life situations may differ from what is shown in the images.
-  This function may not be supported depending on the model.

To lock an anti-theft locking device:

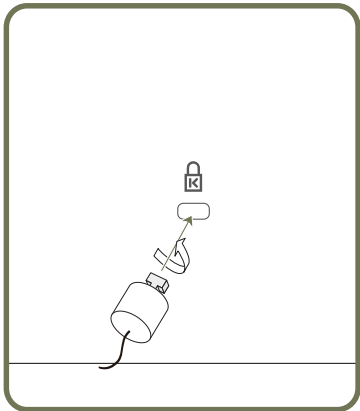





- 1 Fix the cable of your anti-theft locking device to a heavy object such as a desk.
- 2 Put one end of the cable through the loop on the other end.
- 3 Insert the locking device into the anti-theft lock slot at the back of the product.
- 4 Lock the locking device.
 - An anti-theft locking device can be purchased separately.
 - Refer to the user guide provided with your anti-theft locking device for details.
 - Anti-theft locking devices can be purchased at electronics retailers or online.

Ports

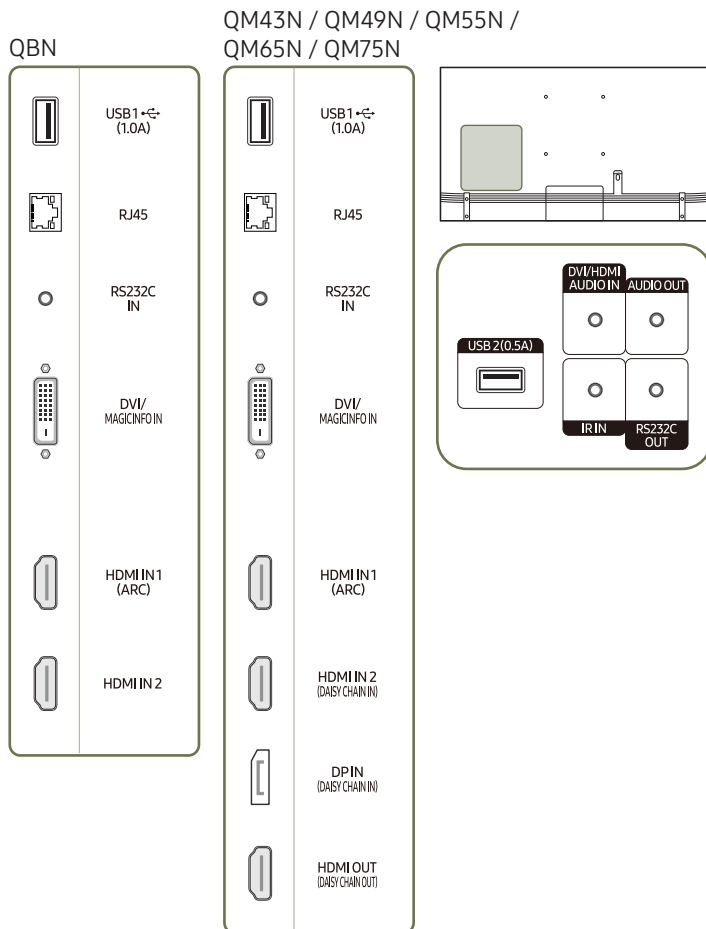
Q*43N/Q*49N/Q*55N/Q*65N/Q*75N

 The color and shape of parts may differ from what is shown. Specifications are subject to change without notice to improve quality.





Port	Description
USB1 (1.0A)	Connect to a USB memory device.  The USB ports on the product accept a maximum constant current of 1.0A. If the maximum value is exceeded, USB ports may not work.
RJ45	Connects to MDC using a LAN cable. (10/100 Mbps)  Use Cat7(*STP Type) cable for the connection. *Shielded Twist Pair.
RS232C IN	Connects to MDC using an RS232C adapter.
DVI/MAGICINFO IN	DVI: Connects to a source device using a DVI cable or HDMI-DVI cable. MAGICINFO IN: To use MagicInfo, make sure to connect the DP-DVI cable.
HDMI IN 1 (ARC)	Connects to a source device using a HDMI cable or HDMI-DVI cable.
HDMI IN 2	
HDMI IN 2 (DAISY CHAIN IN)	<ul style="list-style-type: none"> Connects to a source device using a HDMI cable or HDMI-DVI cable. Connects to another product using a HDMI cable.
DP IN (DAISY CHAIN IN)	Connects to a PC using a DP cable.
HDMI OUT (DAISY CHAIN OUT)	Connects to another product using a HDMI cable.
USB 2(0.5A)	Connect to a USB memory device.  The USB ports on the product accept a maximum constant current of 0.5A. If the maximum value is exceeded, USB ports may not work.
DVI/HDMI AUDIO IN	Receives sound from a source device via an audio cable.
AUDIO OUT	Outputs sound to an audio device via an audio cable.
IR IN	Connects to an external IR cable that receives signals from the remote control.
RS232C OUT	Connects to MDC using an RS232C adapter.

QM85N/QM98N

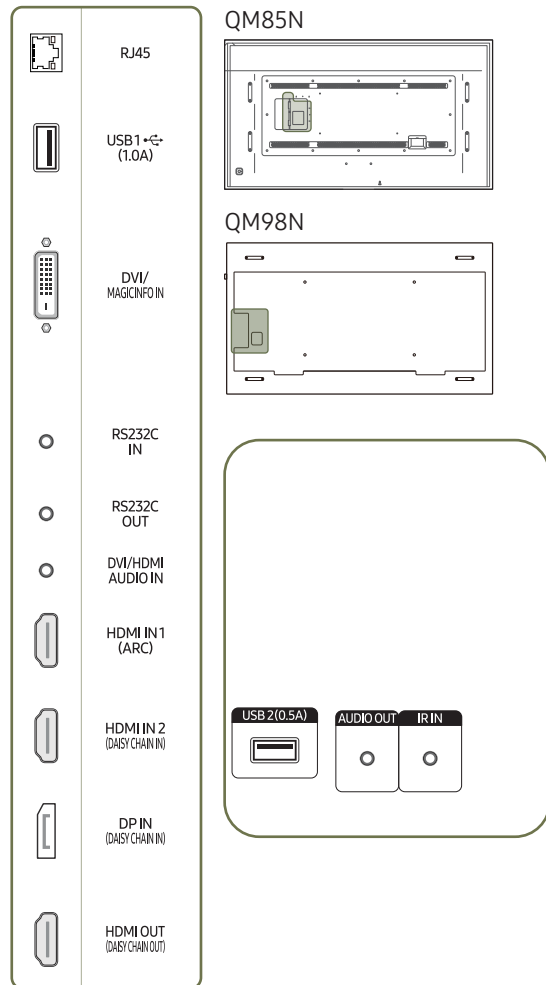

 The color and shape of parts may differ from what is shown. Specifications are subject to change without notice to improve quality.







Port	Description
RJ45	Connects to MDC using a LAN cable. (10/100 Mbps)  Use Cat7(*STP Type) cable for the connection. *Shielded Twist Pair.
USB 1 (1.0A)	Connect to a USB memory device.  The USB ports on the product accept a maximum constant current of 1.0A. If the maximum value is exceeded, USB ports may not work.
DVI/MAGICINFO IN	DVI: Connects to a source device using a DVI cable or HDMI-DVI cable. MAGICINFO IN: To use MagicInfo, make sure to connect the DP-DVI cable.
RS232C IN	Connects to MDC using an RS232C adapter.
RS232C OUT	Connects to MDC using an RS232C adapter.
DVI/HDMI AUDIO IN	Receives sound from a source device via an audio cable.
HDMI IN 1 (ARC)	Connects to a source device using a HDMI cable or HDMI-DVI cable.
HDMI IN 2 (DAISY CHAIN IN)	<ul style="list-style-type: none"> Connects to a source device using a HDMI cable or HDMI-DVI cable. Connects to another product using a HDMI cable.
DP IN (DAISY CHAIN IN)	Connects to a PC using a DP cable.
HDMI OUT (DAISY CHAIN OUT)	Connects to another product using a HDMI cable.
USB 2(0.5A)	Connect to a USB memory device.  The USB ports on the product accept a maximum constant current of 0.5A. If the maximum value is exceeded, USB ports may not work.
AUDIO OUT	Outputs sound to an audio device via an audio cable.
IR IN	Connects to an external IR cable that receives signals from the remote control.

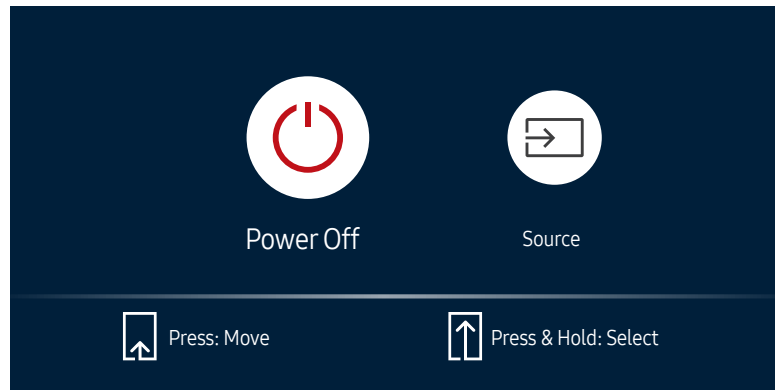

Control menu

Q*43N/Q*49N/Q*55N/Q*65N/Q*75N/ QM98N



-  The power button is located on the bottom of the product.
-  If you press the  button on the product when the product is turned on, the control menu will be displayed.











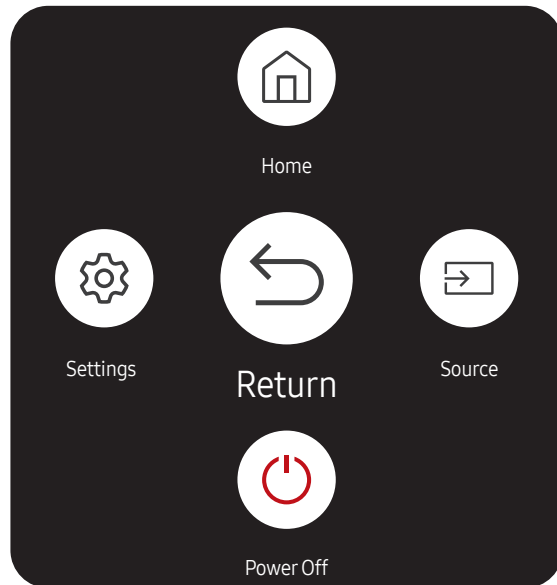

Buttons	Description
 Power Off	<p>Power off the product.</p> <ul style="list-style-type: none">With the control menu screen displayed, briefly press the power button to move the cursor to Power Off , and then press and hold the power button to turn off the product.
 Source	<p>Select the connected input source.</p> <ul style="list-style-type: none">With the control menu screen displayed, briefly press the power button to move the cursor to Source , and then press and hold the power button to display the input source screen.With the input source screen displayed, press and hold the power button to switch to the desired input source.

-  The power button can only be used for **Power Off** and **Source**.
-  To exit from the control menu screen, wait for 3 seconds or more without pressing the  button.

QM85N

 If you press the  button on the product when the product is turned on, the control menu will be displayed.



Buttons	Description
 Home	Enter MagicInfo or URL Launcher mode. <ul style="list-style-type: none"> Move the power button up to select Home  in the control menu.
 Source	Select the connected input source. <ul style="list-style-type: none"> Move the power button right to select Source  in the control menu. When the list of input sources is displayed, move the power button left or right to select the desired input source. Next, press the power button.
 Power Off	Power off the product. <ul style="list-style-type: none"> Move the power button down to select Power Off  in the control menu. Next, press the power button.
 Settings	Display the OSD menu. <ul style="list-style-type: none"> Move the power button left to select Settings  in the control menu. The OSD control screen will appear. Move the power button right to select the desired menu. You can select a sub-menu item by moving the power button up, down, left, or right. To change settings, select the desired menu and press the power button.
 Return	Exit the control menu.

 To exit from the control menu screen, wait for 3 seconds or more without pressing the  button.

  Button action guide

 **Press: Select:** Navigate to the desired menu and quickly press the  button on the product to select the menu.

 **Press & Hold: Exit:** Press and hold the  button on the product to exit the menu.

Before Installing the Product (Installation Guide)

To prevent injury, this apparatus must be securely attached to the floor/wall in accordance with the installation instructions.

- Ensure that an authorised installation company installs the wall mount.
- Otherwise, it may fall and cause personal injury.
- Make sure to install the specified wall mount.

Tilting Angle and Rotation

Contact Samsung Customer Service Centre for further details.

- The product can be tilted at a maximum angle of 15° from a perpendicular wall surface.
- To use the product in Portrait mode, rotate clockwise until the power indicator (A or B) is positioned as shown in the images below.

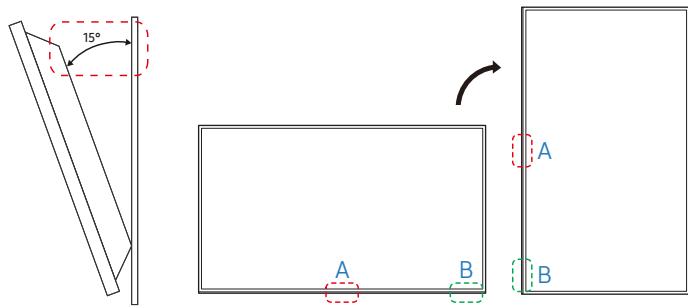

Do not use this model installed on a ceiling, floor, or table.

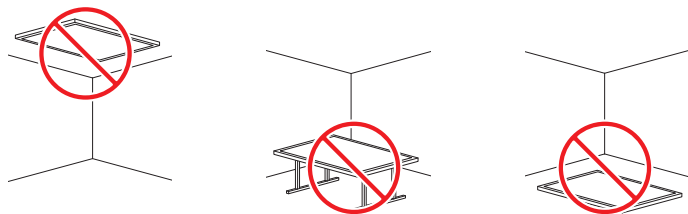

Ventilation

Contact Samsung Customer Service Centre for further details.

Installation on a Perpendicular Wall

A Minimum 40 mm

B Ambient temperature: Under 35 °C

When installing the product on a perpendicular wall, allow at least 40 mm of space between the product and wall surface for ventilation and ensure that the ambient A temperature is kept below 35 °C.

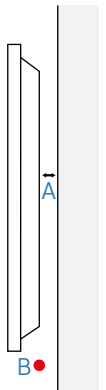

Installation on an Indented Wall

A Minimum 40 mm

B Minimum 70 mm

C Minimum 50 mm

D Minimum 50 mm

E Ambient temperature: Under 35 °C

When installing the product on an indented wall, allow at least the space specified above between the product and wall for ventilation and ensure that the ambient temperature is kept below 35 °C.

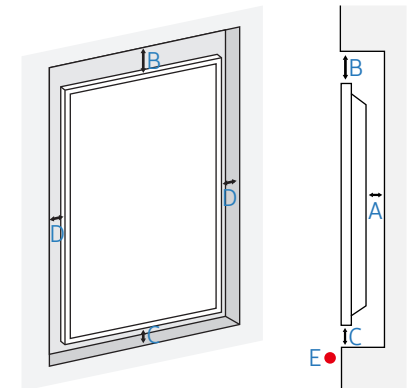

Installing the Wall Mount

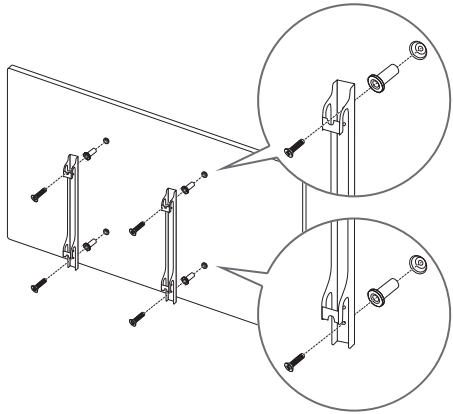

Preparing before installing Wall-Mount

To install a wall-mount from another manufacturer, use the Holder-Ring.

Installing the Wall Mount

- The wall mount kit (sold separately) allows you to mount the product on the wall.
- The provided image is only for reference. For detailed information on installing the wall mount, see instructions provided with the wall mount.
- We recommend you contact a technician for assistance when installing the wall mount bracket.
- Samsung Electronics is not responsible for any damage to the product or injury to yourself or others if you select to install the wall mount on your own.

Wall Mount Kit Specifications (VESA)

 Install your wall mount on a solid wall perpendicular to the floor. To install the product on the other wall area, contact the nearest agency. If you install the product on a slanted wall, it may fall and result in severe personal injury.

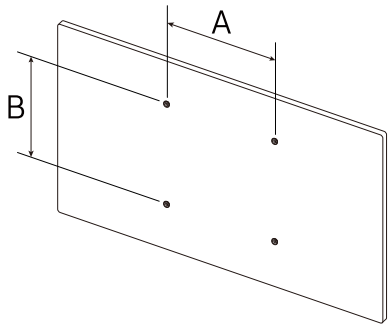

- Samsung wall mount kits contain a detailed installation manual and all parts necessary for assembly are provided.
- Do not use screws that are longer than the standard length or do not comply with the VESA standard screw specifications. Screws that are too long may cause damage to the inside of the product.
- For wall mounts that do not comply with the VESA standard screw specifications, the length of the screws may differ depending on the wall mount specifications.
- Do not fasten the screws too firmly. This may damage the product or cause the product to fall, leading to personal injury. Samsung is not liable for these kinds of accidents.
- Samsung is not liable for product damage or personal injury when a non-VESA or non-specified wall mount is used or the consumer fails to follow the product installation instructions.
- Do not mount the product at more than a 15 degree tilt.
- Always have at least two people mount the product on a wall. (Four or more people for the 82-inch size and larger models.)
- Standard dimensions for wall mount kits are shown in the table below.

Model Name	VESA screw hole specs (A * B) in millimeters (inches)	Standard Screw	Quantity
QB43N / QB49N / QB55N / QM43N / QM49N / QM55N	200 × 200 (7.9 × 7.9)	M8	4
QB65N / QB75N / QM65N / QM75N	400 × 400 (15.7 × 15.7)		
QM85N	600 × 400 (23.6 × 15.7)		
QM98N	900 × 600 (35.4 × 23.6)		

 Do not install your Wall Mount Kit while your product is turned on. It may result in personal injury due to electric shock.

Chapter 02

Specifications

General

Model Name		QB43N / QM43N	QB49N / QM49N	QB55N / QM55N
Panel	Size	43 CLASS (42.5 inches / 107.9 cm)	49 CLASS (48.5 inches / 123.2 cm)	55 CLASS (54.6 inches / 138.7 cm)
	Display area	941.184 mm (H) x 529.416 mm (V) 37.1 inches (H) x 20.8 inches (V)	1073.78 mm (H) x 604.0 mm (V) 42.3 inches (H) x 23.8 inches (V)	1209.6 mm (H) x 680.4 mm (V) 47.6 inches (H) x 26.8 inches (V)



Model Name		QB65N / QM65N	QB75N / QM75N
Panel	Size	65 CLASS (64.5 inches / 163.9 cm)	75 CLASS (74.5 inches / 189.3 cm)
	Display area	1428.48 mm (H) x 803.52 mm (V) 56.2 inches (H) x 31.6 inches (V)	1650.24 mm (H) x 928.26 mm (V) 65.0 inches (H) x 36.5 inches (V)

Model Name		QM85N	QM98N
Panel	Size	85 CLASS (84.5 inches / 214.7 cm)	98 CLASS (97.5 inches / 247.7 cm)
	Display area	1872.0 mm (H) x 1053.0 mm (V) 73.7 inches (H) x 41.5 inches (V)	2158.848 mm (H) x 1214.352 mm (V) 85.0 inches (H) x 47.8 inches (V)

Power Supply		AC100-240V~ 50/60Hz Refer to the label at the back of the product as the standard voltage can vary in different countries.
Environmental considerations	Operating	Temperature: 32 °F – 104 °F (0 °C – 40 °C) * For installing the housing, keep the internal temperature at 40 °C or below. Humidity: 10% – 80%, non-condensing
	Storage	Temperature: -4 °F – 113 °F (-20 °C – 45 °C) Humidity: 5% – 95%, non-condensing * Applicable before the product package is unpacked.

 **Plug-and-Play**

This monitor can be installed and used with any Plug-and-Play compatible systems. Two-way data exchange between the monitor and PC system optimizes the monitor settings. Monitor installation takes place automatically. However, you can customize the installation settings if desired.

-  Due to the nature of the manufacturing of this product, approximately 1 pixel per million (1ppm) may appear brighter or darker on the panel. This does not affect product performance.
-  This is a class A product. In a domestic environment this product may cause radio interference in which case the user may be required to take adequate measures.
-  For detailed device specifications, visit the Samsung Electronics website.

(USA only)

Dispose unwanted electronics through an approved recycler.

To find the nearest recycling location, go to our website: www.samsung.com/recyclingdirect or call, (877) 278 - 0799

Preset Timing Modes

 This product can be set to only one resolution for each screen size to obtain the optimum picture quality due to the nature of the panel. Using a resolution other than the specified resolution may degrade the picture quality. To avoid this, it is recommended that you select the optimum resolution specified for your product.

Horizontal Frequency

The time required to scan a single line from the left to the right side of the screen is called a horizontal cycle. The reciprocal number of a horizontal cycle is called horizontal frequency. Horizontal frequency is measured in kHz.

Vertical Frequency

The product displays a single image multiple times per second (like a fluorescent light) to display what the viewer sees. The rate of a single image being displayed repeatedly per second is called vertical frequency or refresh rate. Vertical frequency is measured in Hz.

Model Name		QB43N / QB49N / QB55N / QB65N / QB75N	QM43N / QM49N / QM55N / QM65N / QM75N / QM85N / QM98N
Synchronization	Horizontal Frequency	30 - 81 kHz (DVI), 30 - 90 kHz (HDMI)	30 - 81 kHz (DVI), 30 - 90 kHz (HDMI), 30 - 134 kHz (DisplayPort)
	Vertical Frequency	48 - 75 Hz (DVI), 24 - 75 Hz (HDMI)	48 - 75 Hz (DVI), 24 - 75 Hz (HDMI), 56 - 75 Hz (DisplayPort)
Resolution	Optimum resolution	1920 × 1080 @ 60 Hz (DVI)	1920 × 1080 @ 60 Hz (DVI)
	Maximum resolution	3840 × 2160 @ 60 Hz (HDMI)	3840 × 2160 @ 60 Hz (HDMI) 3840 × 2160 @ 60 Hz (DisplayPort)

The screen will automatically be adjusted if a signal that belongs to the following standard signal modes is transmitted from your PC. If the signal transmitted from the PC does not belong to the standard signal modes, the screen may be blank with the power indicator on. In such a case, change the settings according to the following table by referring to the graphics card user manual.

Resolution	Horizontal Frequency (kHz)	Vertical Frequency (Hz)	Pixel Clock (MHz)	Sync Polarity (H/V)
IBM, 640 x 480	31.469	59.940	25.175	-/-
IBM, 720 x 400	31.469	70.087	28.322	-/+
MAC, 640 x 480	35.000	66.667	30.240	-/-
MAC, 832 x 624	49.726	74.551	57.284	-/-
MAC, 1152 x 870	68.681	75.062	100.000	-/-
VESA, 640 x 480	31.469	59.940	25.175	-/-
VESA, 640 x 480	37.861	72.809	31.500	-/-
VESA, 640 x 480	37.500	75.000	31.500	-/-
VESA, 800 x 600	35.156	56.250	36.000	+/+
VESA, 800 x 600	37.879	60.317	40.000	+/+
VESA, 800 x 600	48.077	72.188	50.000	+/+
VESA, 800 x 600	46.875	75.000	49.500	+/+
VESA, 1024 x 768	48.363	60.004	65.000	-/-
VESA, 1024 x 768	56.476	70.069	75.000	-/-
VESA, 1024 x 768	60.023	75.029	78.750	+/+
VESA, 1152 x 864	67.500	75.000	108.000	+/+
VESA, 1280 x 720	45.000	60.000	74.250	+/+
VESA, 1280 x 800	49.702	59.810	83.500	-/+

Resolution	Horizontal Frequency (kHz)	Vertical Frequency (Hz)	Pixel Clock (MHz)	Sync Polarity (H/V)
VESA, 1280 x 1024	63.981	60.020	108.000	+/+
VESA, 1280 x 1024	79.976	75.025	135.000	+/+
VESA, 1366 x 768	47.712	59.790	85.500	+/+
VESA, 1440 x 900	55.935	59.887	106.500	-/+
VESA, 1600 x 900	60.000	60.000	108.000	+/+
VESA, 1680 x 1050	65.290	59.954	146.250	-/+
VESA, 1920 x 1080 (DVI)	67.500	60.000	148.500	+/+
VESA, 2560 x 1440	88.787	59.951	241.500	+/-
CEA, 3840 x 2160 (HDMI)	67.500	60.000	297.000	+/+
VESA, 3840 x 2160 (DP)	133.313	59.997	533.250	+/-

 The QBN models are not available in the VESA 3840 x 2160 (DP).

Chapter 03

Appendix

License



Manufactured under license from Dolby Laboratories. Dolby, Dolby Audio, Pro Logic, and the double-D symbol are trademarks of Dolby Laboratories.



The terms HDMI and HDMI High-Definition Multimedia Interface, and the HDMI Logo are trademarks or registered trademarks of HDMI Licensing LLC in the United States and other countries.

Open Source Licence Notice

In the case of using open source software, Open Source Licences are available on the product menu. Open Source Licence Notice is written only English.

For information on the Open Source Licence Notice, contact the Samsung Customer Center or send email to oss.request@samsung.com.



THIS PRODUCT IS SOLD WITH A LIMITED LICENCE AND IS AUTHORISED TO BE USED ONLY IN CONNECTION WITH HEVC CONTENT THAT MEETS EACH OF THE THREE FOLLOWING QUALIFICATIONS: (1) HEVC CONTENT ONLY FOR PERSONAL USE; (2) HEVC CONTENT THAT IS NOT OFFERED FOR SALE; AND (3) HEVC CONTENT THAT IS CREATED BY THE OWNER OF THE PRODUCT.

THIS PRODUCT MAY NOT BE USED IN CONNECTION WITH HEVC ENCODED CONTENT CREATED BY A THIRD PARTY, WHICH THE USER HAS ORDERED OR PURCHASED FROM A THIRD PARTY, UNLESS THE USER IS SEPARATELY GRANTED RIGHTS TO USE THE PRODUCT WITH SUCH CONTENT BY A LICENSED SELLER OF THE CONTENT.

YOUR USE OF THIS PRODUCT IN CONNECTION WITH HEVC ENCODED CONTENT IS DEEMED ACCEPTANCE OF THE LIMITED AUTHORITY TO USE AS NOTED ABOVE.
