

# GARANT Schraubstock Stahl

GARANT vice steel / GARANT etau atelier / GARANT morsa acciaio / GARANT tornillo de banco acero

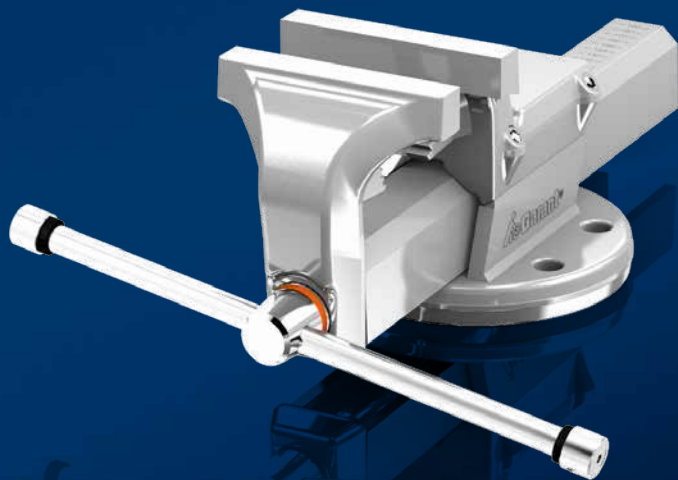

Bedienungsanleitung / User manual / Manual de instrucciones  
Manuel d'utilisation / Manuale d'uso



DE

EN

FR

IT

ES

DE

EN

FR

IT

ES

# Inhalt

- 1. Zu diesem Dokument..... 4
- 1.1 Symbole und Darstellungsmittel ..... 4
- 2. Sicherheitshinweise ..... 5
- 2.1 Transport und Montage ..... 5
- 2.2 Bestimmungsgemäße Verwendung ..... 5
- 3. Montage..... 5
- 3.1 Benötigtes Werkzeug und Befestigungsmaterial ..... 5
- 3.2 – 3.5 Montage des Schraubstocks..... 6
- 3.6 Montage der Drehplatte ..... 7
- 3.7. Montage der wechselbaren Backen..... 7
- 4. Demontage ..... 8
- 5. Instandhaltung ..... 8
- 6. Entsorgung..... 9
- 7. Ersatzteile und Zubehör ..... 9

DE

EN

FR

IT

ES



# 1. Zu diesem Dokument

## 1.1 Symbole und Darstellungsmittel

### Warnhinweise



In dieser Anleitung werden Warnhinweise verwendet, um Sie vor Sach- und Personenschäden zu warnen.

- ▶ Lesen und beachten Sie diese Warnhinweise immer.
- ▶ Befolgen Sie alle Maßnahmen, die mit dem Warnsymbol und Warnwort gekennzeichnet sind.

Warnsymbol	Warnwort	Bedeutung
	<b>GEFAHR</b>	Gefahren für Personen. Nichtbeachtung führt zu Tod oder schweren Verletzungen.
	<b>WARNUNG</b>	Gefahren für Personen. Nichtbeachtung kann zu Tod oder schweren Verletzungen führen.
	<b>VORSICHT</b>	Gefahren für Personen. Nichtbeachtung kann zu leichten Verletzungen führen.
—	<b>VORSICHT</b>	Informationen zur Vermeidung von Sachschäden, zum Verständnis oder zum Optimieren der Arbeitsabläufe.

### Weitere Symbole und Darstellungsmittel

Um die korrekte Bedienung zu verdeutlichen, sind wichtige Informationen und technische Hinweise besonders herausgestellt.

Symbol	Bedeutung
	„Wichtiger Hinweis“
	„Zusätzliche Information“: Verweis auf andere Dokumente und Informationen
▶	Symbol für eine Handlung: Hier müssen Sie etwas tun.

## 2. Sicherheitshinweise



- ▶ Gebrauchsanweisung lesen, beachten, für späteres Nachschlagen aufbewahren und jederzeit verfügbar halten.

### 2.1 Transport und Montage

- ▶ Nur geeignete Lasthebemittel für den Transport zum Aufstellort verwenden.
- ▶ Transportwege absichern.



- ▶ Schutzschuhe und Schutzhelm tragen.





### 2.2 Bestimmungsgemäße Verwendung

- ▶ Ein Schraubstock ist eine Vorrichtung zum Feststellen von Werkstücken während Ihrer Bearbeitung.
- ▶ Garantieverlust:  
Der Schraubstock ist nur mit dem eigenen Spindelschlüssel zu verwenden.  
Das Verwenden von Hilfsmitteln, wie z. B. Rohre oder dergleichen, ist beim Spannen nicht zulässig. Sobald Hilfsmittel beim Spannen verwendet werden, erlischt die gewährte Garantiezeit.

## 3. Montage

### 3.1. Benötigtes Werkzeug und Befestigungsmaterial

- ▶ In Verbindung mit Original Hoffmann Arbeitsplatte Stärke 50mm.

Werkzeug / Material	100 / 120	140 / 160	
	Führung einstellen:	6 mm	8 mm
	Wechselbacken tauschen:	5 mm	6 mm
	19 mm	24 mm	
 Schraubstock	Bitte entsprechend verwendeten Schrauben vorbohren.		
 Schraubstock	Für Plattenstärke 50 mm:	2×Größe 12 mm	4×Größe 16 mm
 Drehplatte	Für Plattenstärke 50 mm:	3×Größe 10 mm	3×Größe 12 mm

### 3.2. Montage des Schraubstocks

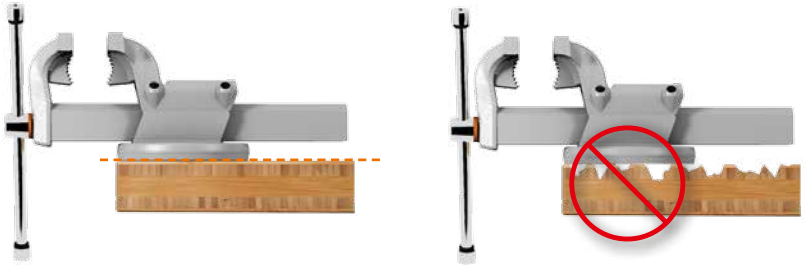

### 3.3.



### 3.4.

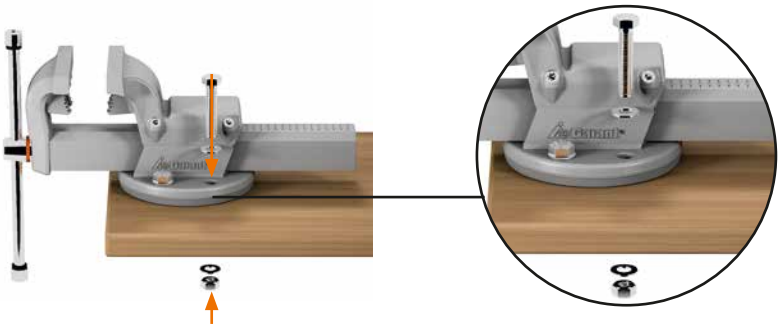

### 3.5.

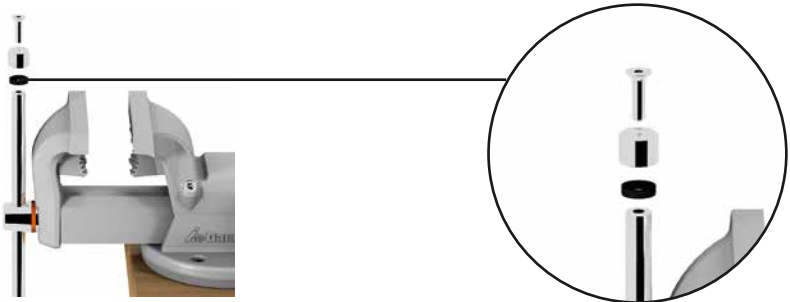

### 3.6. Montage der Drehplatte

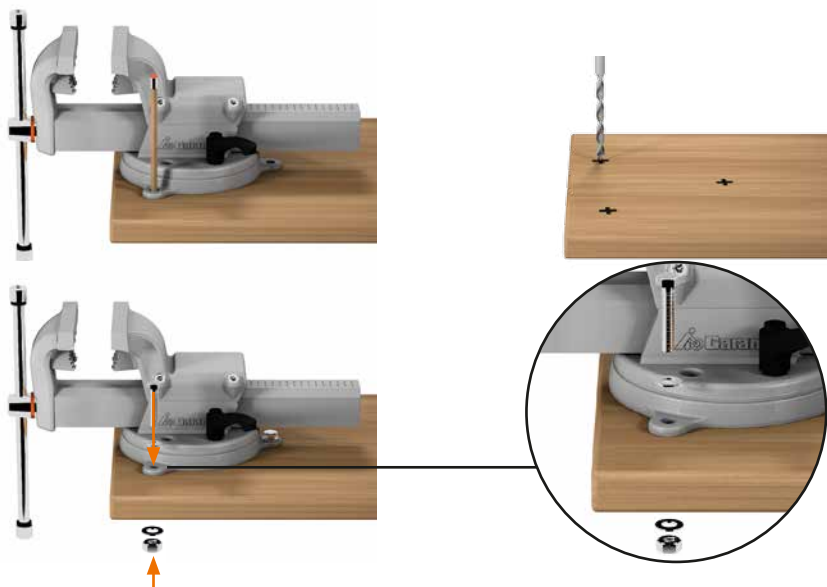

### 3.7. Montage der wechselbaren Backen



## 4. Demontage

- ▶ Werkstücke vom Schraubstock lösen.
- ▶ Schraubstock in umgekehrter Reihenfolge der Montage demontieren.

## 5. Instandhaltung

- ▶ Regelmäßig alle Komponenten und Verschraubungen der Schraubstöcke und Drehplatte auf festen Sitz, Unversehrtheit und Funktion prüfen.
- ▶ Nachstellen der Führung.

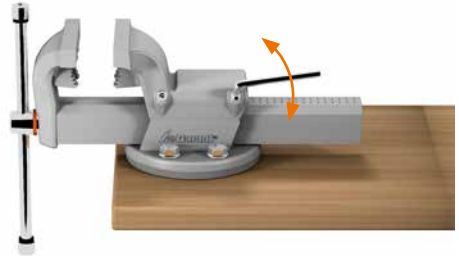

Keinesfalls darf die Führung so stramm eingestellt werden, dass sich das Vorderteil **ruckweise** bewegt.

- ▶ Regelmäßig ölen.

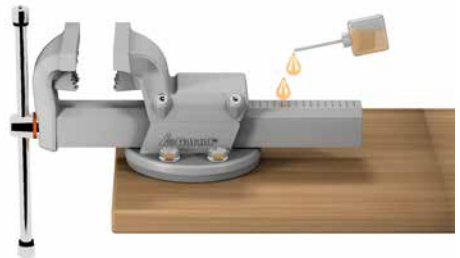





### Schweißarbeiten:

Da die Spannflächen der Backen als auch der Amboss sorgfältig oberflächengehärtet sind, ist bei Schweiß- und Lötarbeiten an Werkstücken, die im Schraubstock eingespannt sind, besonders darauf zu achten, dass die Flamme des Schweißbrenners diese nicht ausglüht.

Gegebenenfalls sind die Spannflächen oder der Amboss mit feuerfesten bzw. hitzebeständigen Materialien abzudecken.

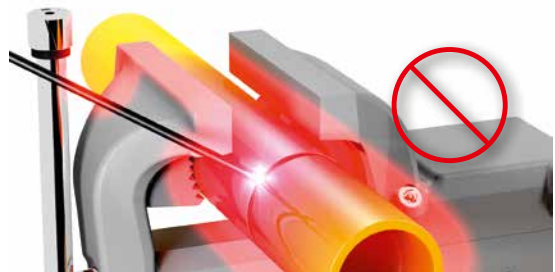

## 6. Entsorgung

- Schraubstock und alle Zubehörteile gemäß den örtlich geltenden Vorschriften entsorgen.

## 7. Ersatzteile und Zubehör



### Ersatzteile:

erhältlich bei der Hoffmann Group: [www.hoffmann-group.com](http://www.hoffmann-group.com)

### Zubehör:

Höhenverstellgerät, Drehplatte, Ersatzbacken, Schonbacken  
siehe „Katalog Betriebseinrichtungen“ der Hoffmann Group.

DE

EN

FR

IT

ES

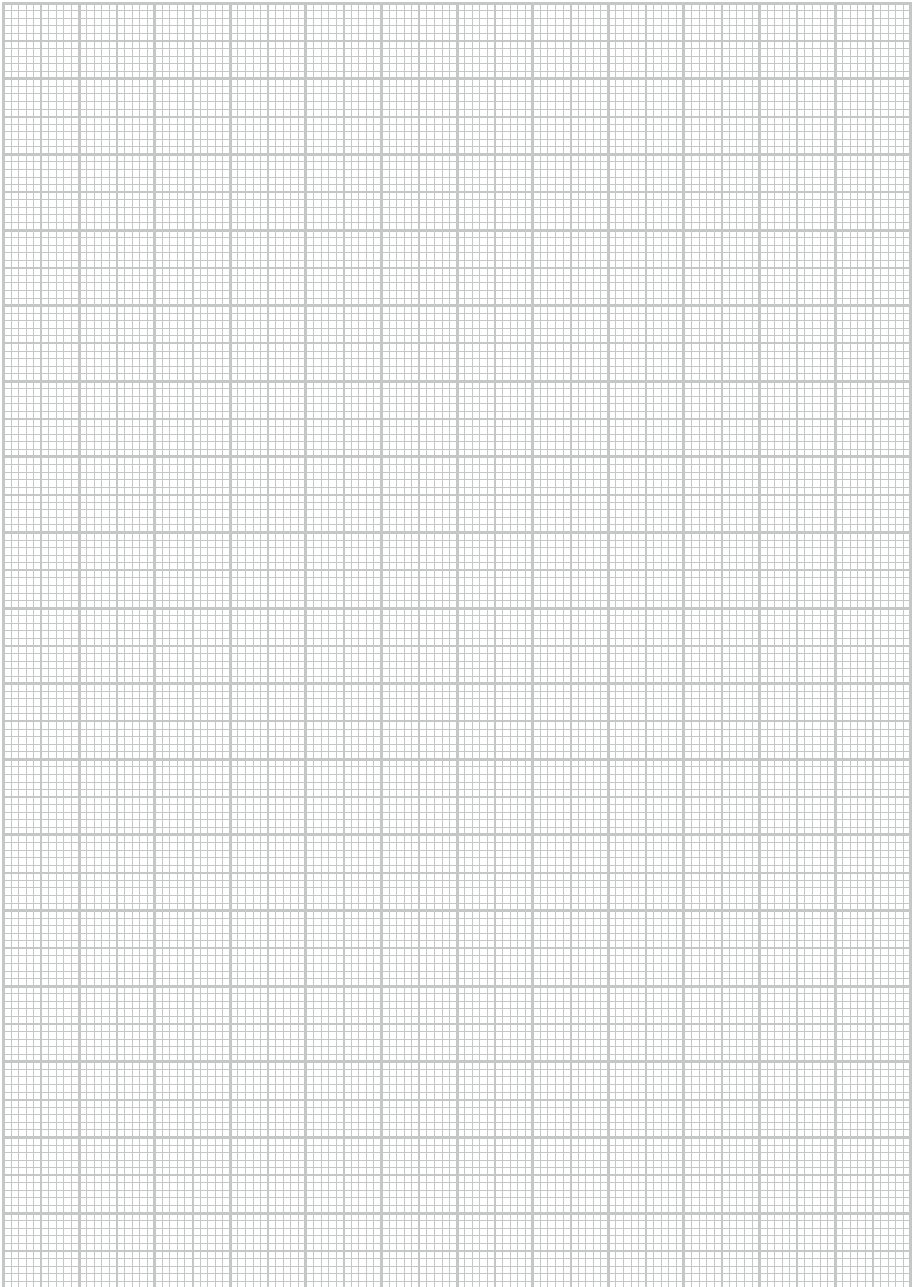

# Content

- 1. About this document ..... 12
- 1.1. Symbols and means of representation ..... 12
- 2. Safety instructions ..... 13
- 2.1. Transport and assembly ..... 13
- 2.2. Intended use..... 13
- 3. Installation ..... 13
- 3.1. Tools and attachment materials required ..... 13
- 3.2. - 5 Installation of the vice ..... 14
- 3.6. Installation of the swivel base..... 15
- 3.7. Installation of the interchangeable jaws ..... 15
- 4. Dismantling..... 16
- 5. Maintenance ..... 16
- 6. Disposal ..... 17
- 7. Spare parts and accessories ..... 17

DE

EN

FR

IT

ES



# 1. About this document

## 1.1 Symbols and means of representation

### Warnings



Warnings are used in this manual to warn you about damage and injury.

- ▶ Read these warnings and always heed them.
- ▶ Take all measures that are marked with the warning symbol and warning word.

Warning symbol	Warning word	Meaning
	<b>DANGER</b>	Hazards for personnel. If the warning is disregarded death or serious physical injuries will result.
	<b>WARNING</b>	Hazards for personnel. If the warning is disregarded death or serious physical injuries may result.
	<b>CAUTION</b>	Hazards for personnel. If the hazard is disregarded minor injuries may result.
—	<b>CAUTION</b>	Information on avoiding damage, for understanding or for optimising work sequences.

### Further symbols and means of representation

To clarify correct operation, important information and technical descriptions are specially highlighted.

Symbol	Meaning
	"Important note"
	"Additional information": reference to other documents and information
▶	Symbol for an action: here you must do something.

## 2. Safety instructions



- ▶ Read the instructions for use, follow them and keep them available for later reference.

### 2.1 Transport and assembly

- ▶ Use only suitable lifting gear for transport to the installation location.
- ▶ Secure transport routes.



Wear safety shoes and a hard hat.





### 2.2 Intended use

- ▶ A vice is a device for securing workpieces during processing.
- ▶ Invalidation of warranty cover:  
The vice must be used only with its own spindle wrench.  
When clamping the workpiece, the use of supplementary leverage such as pipes is not permissible. If supplementary leverage is used when clamping, this invalidates the warranty.

## 3. Installation

### 3.1. Tools and attachment materials required

- ▶ In connection with the original Hoffmann mounting plate, 50 mm thick.

Tool / Material	100 / 120	140 / 160	
	Adjust guide:	6 mm	8 mm
	Change interchangeable jaws:	5 mm	6 mm
	19 mm	24 mm	
 Vice	Please pre-drill to suit the screws used.		
 Vice	For worktop thickness 50 mm:	2×size 12 mm	4×size 16 mm
 Swivel base	For worktop thickness 50 mm:	3×size 10 mm	3×size 12 mm

**3.2. Installation of the vice**

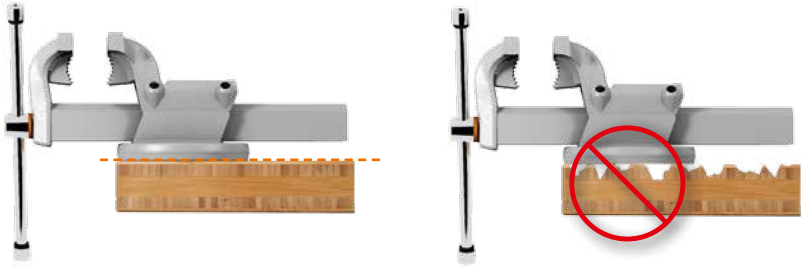

**3.3.**



**3.4.**

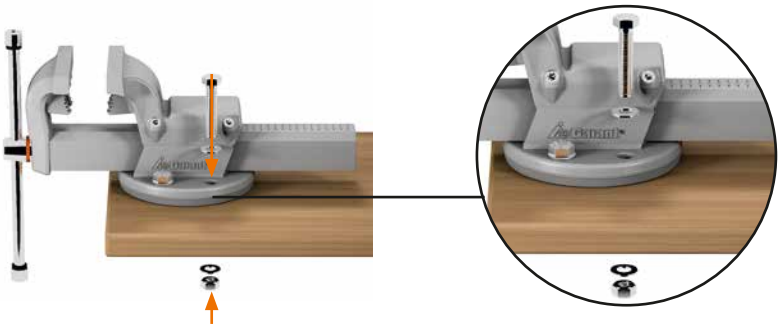

**3.5.**

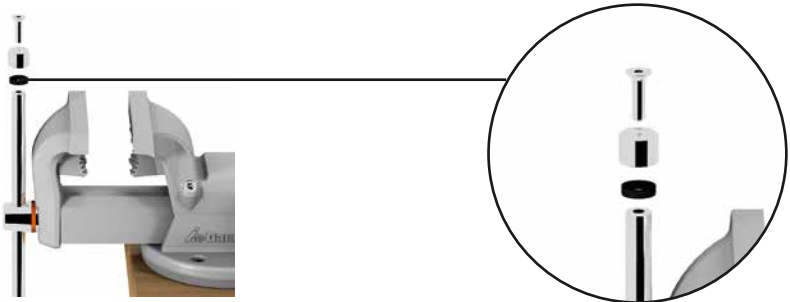

DE

EN

FR

IT

ES

### 3.6. Installation of the swivel base

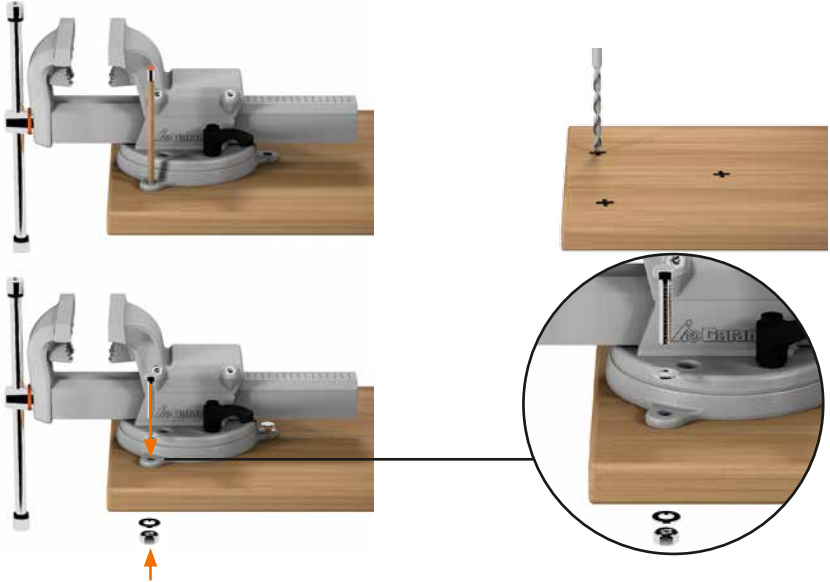

### 3.7. Installation of the interchangeable jaws



## 4. Dismantling

- ▶ Remove workpieces from the vice.
- ▶ Disassemble the vice in the reverse order to assembly.

## 5. Maintenance

- ▶ Regularly check all components and screw fastenings on the vice and swivel base for tightness, good condition and operation.
- ▶ Adjusting the guide.

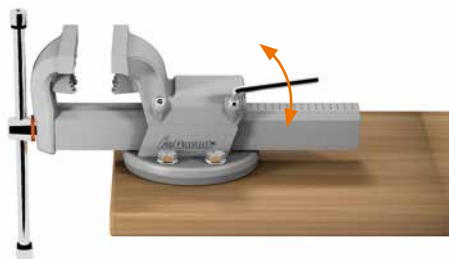

Under no circumstances may the guide be adjusted so tightly that the front part moves **jerkily**.

- ▶ Oil the vice regularly.

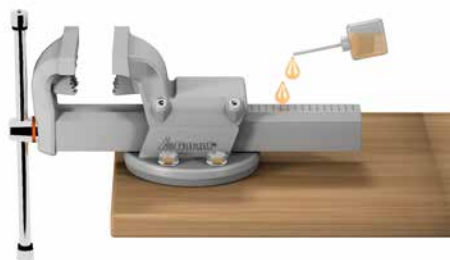





**Welding:**

Since the anvil and also the clamping faces of the jaws have been carefully surface hardened, when performing welding or brazing work on workpieces clamped in the vice take great care that the welding/brazing flame does not cause loss of hardening of these surfaces. If necessary, cover the anvil or clamping faces with flame-proof or heat-resistant materials.

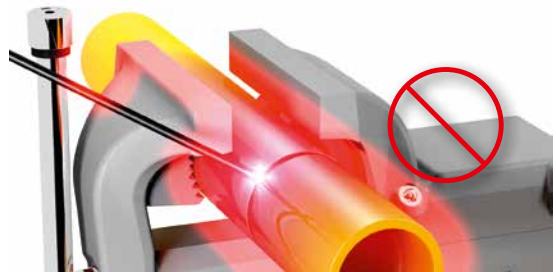

6. Disposal

- ▶ Dispose of the vice and all accessory parts in accordance with local regulations.

7. Spare parts and accessories



**Spare parts:**

obtainable from the Hoffmann Group: [www.hoffmann-group.com](http://www.hoffmann-group.com)

**Accessories:**

Height adjuster, swivel base, spare jaws, soft jaws are available, see the Hoffmann Group "Workstations and storage" catalogue.

DE

EN

FR

IT

ES

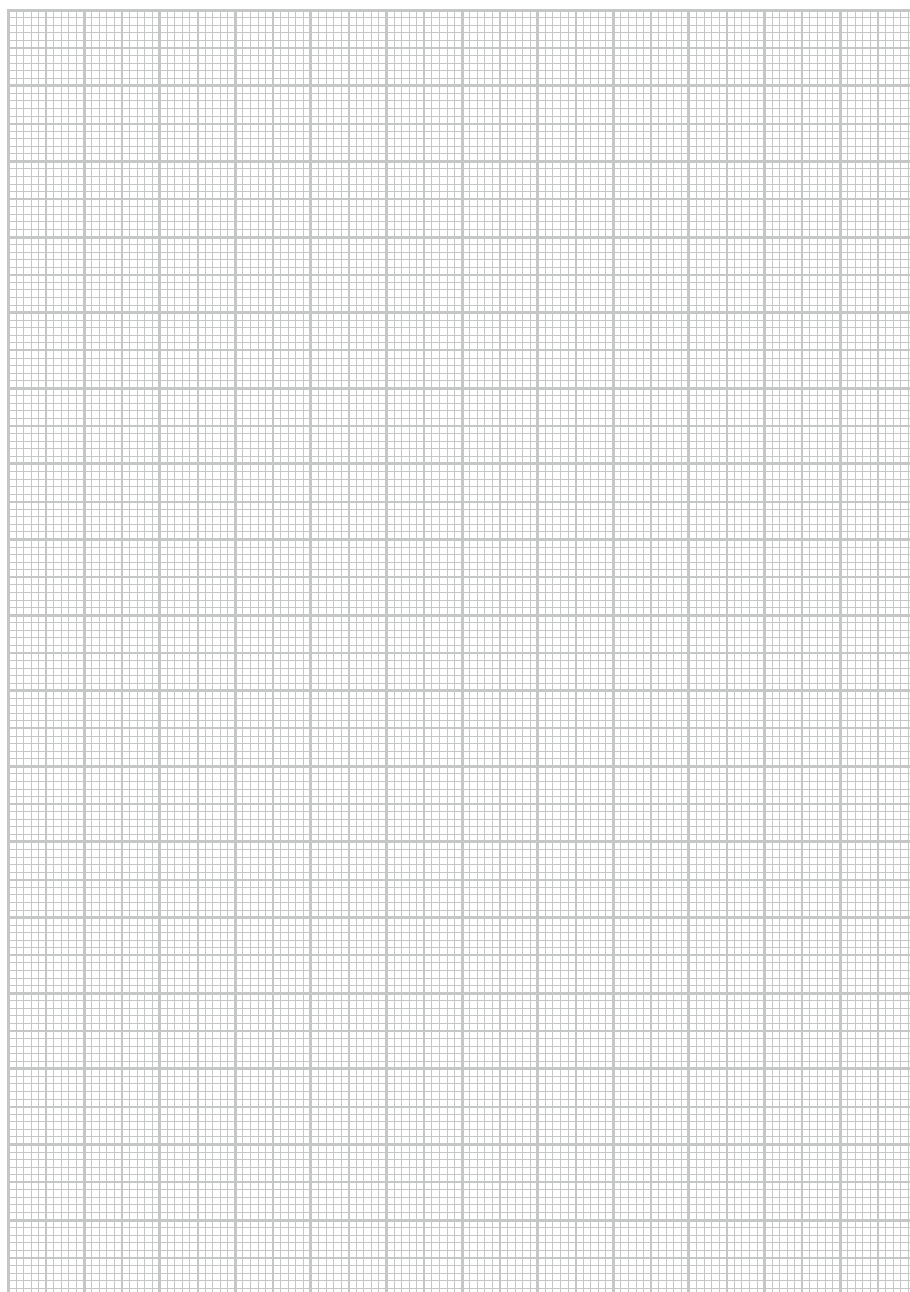

# Sommaire

1.	A propos de ce document .....	20
1.1.	Symboles et représentations .....	20
2.	Consignes de sécurité .....	21
2.1.	Transport et montage .....	21
2.2.	Utilisation conforme .....	21
3.	Montage.....	21
3.1.	Outillage et matériel de fixation nécessaires .....	21
3.2. - 5	Montage de l'étau.....	22
3.6.	Montage de la base pivotante .....	23
3.7.	Montage des mors interchangeables.....	23
4.	Démontage .....	24
5.	Maintenance .....	24
6.	Mise au rebut.....	25
7.	Pièces de rechange et accessoires .....	25

DE

EN

FR

IT

ES



# 1. A propos de ce document

## 1.1 Symboles et représentations

### Avertissements



Cette notice contient des avertissements sur les dommages matériels et corporels.

- ▶ Lisez ces avertissements et tenez-en toujours compte.
- ▶ Respectez toutes les mesures identifiées par un symbole et un terme d'avertissement.

Symbole d'avertissement	Terme d'avertissement	Signification
	<b>DANGER</b>	Risques pour les personnes. Le non-respect entraîne la mort ou des blessures graves.
	<b>AVERTISSEMENT</b>	Risques pour les personnes. Le non-respect peut entraîner la mort ou des blessures graves.
	<b>ATTENTION</b>	Risques pour les personnes. Le non-respect peut entraîner des blessures légères.
—	<b>ATTENTION</b>	Informations destinées à prévenir les dégâts matériels, ainsi qu'à comprendre et optimiser les cycles de travail.

### Autres symboles et représentations

Pour garantir une utilisation correcte, les informations importantes et les conseils techniques sont mis en évidence.

Symbole	Signification
	"Remarque importante"
	"Information supplémentaire" : renvoie à d'autres documents et informations
▶	Symbole d'une action : une action de votre part est nécessaire.

## 2. Consignes de sécurité



- ▶ Lisez, respectez et conservez la notice d'utilisation à des fins de consultation ultérieure, et gardez-la toujours à disposition.

### 2.1 Transport et montage

- ▶ N'utilisez que des engins de levage adaptés au transport vers le lieu de l'installation.
- ▶ Dégagez les voies de transport.



- ▶ Portez des chaussures de sécurité et un casque de protection.





### 2.2 Utilisation conforme

- ▶ Un étau est un dispositif permettant de fixer des pièces pendant leur usinage.
- ▶ Perte de garantie :  
L'étau ne peut être utilisé qu'avec la clé à vis appropriée.  
L'utilisation de dispositifs auxiliaires, tels que tubes ou similaires, n'est pas autorisée lors du serrage. La période de garantie octroyée expire dès l'utilisation de dispositifs auxiliaires pour le serrage.

## 3. Montage

### 3.1. Outillage et matériel de fixation nécessaires

En association avec un plan de travail Hoffmann d'origine de 50 mm d'épaisseur.

Outil / Matériel	100 / 120	140 / 160	
	Réglage du guidage:	6 mm	8 mm
	Remplacement des mors de rechange:	5 mm	6 mm
	19 mm	24 mm	
 Etou	Il est recommandé de pré-percer les vis utilisées.		
 Etou	Pour épaisseur de plan de travail de 50 mm:	2x taille 12 mm	4x taille 16 mm
 Base pivotante	Pour épaisseur de plan de travail de 50 mm:	3x taille 10 mm	3x taille 12 mm

### 3.2. Montage de l'étau

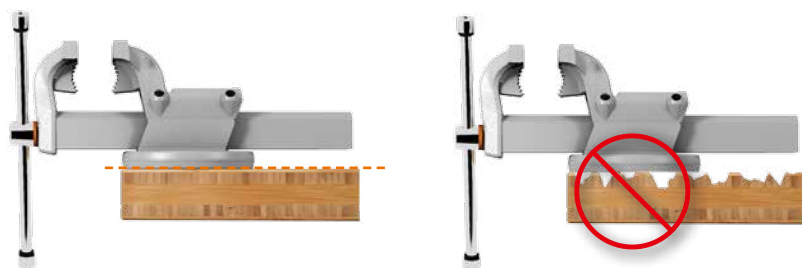

### 3.3.



### 3.4.

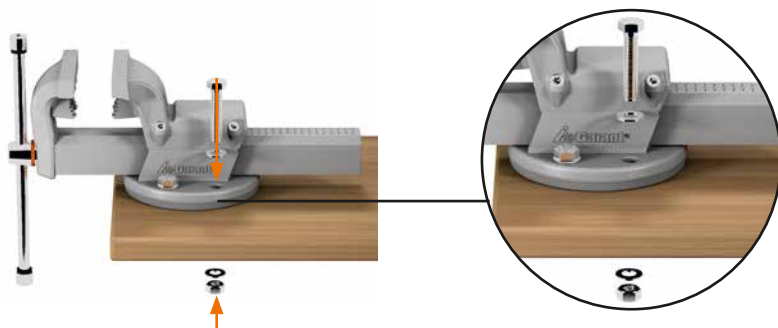

### 3.5.

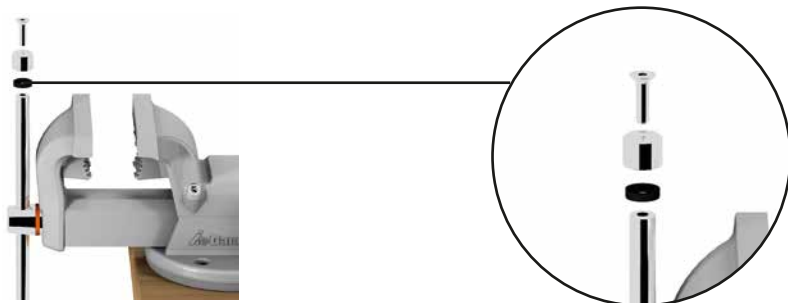

### 3.6. Montage de la base pivotante

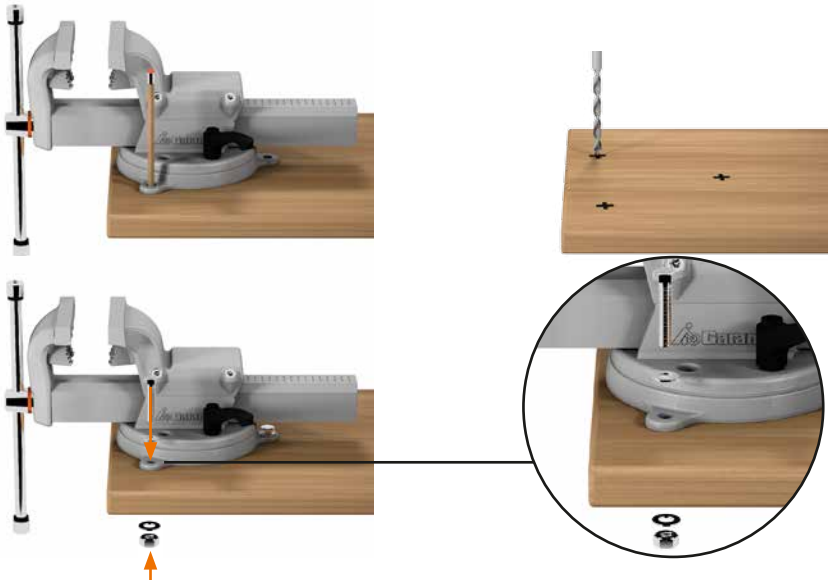

### 3.7. Montage des mors interchangeables



## 4. Démontage

- ▶ Desserrez les pièces de l'étau.
- ▶ Démontez l'étau en suivant l'ordre inverse des étapes de montage.

## 5. Maintenance

- ▶ Vérifiez régulièrement si tous les composants et raccords de l'étau et de la base pivotante sont bien en place, intacts et fonctionnels.
- ▶ Réglez le guidage.

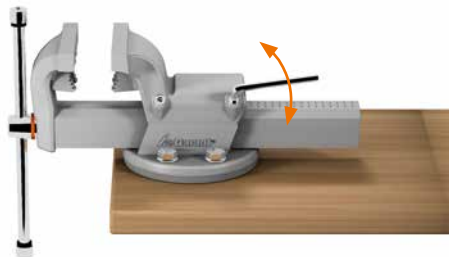

En aucun cas, le guidage ne peut être tendu de manière à ce que la partie avant puisse se déplacer **par à-coups**.

- ▶ Procédez à un graissage régulier.

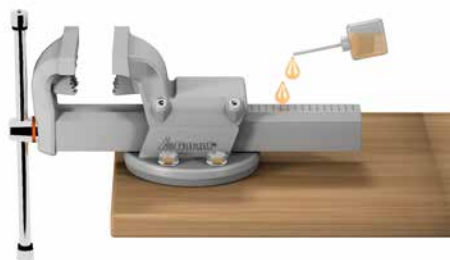



**Travaux de soudure :**

Etant donné que les surfaces de serrage des mors et l'enclume présentent une surface minutieusement trempée, il convient de veiller particulièrement à ce que la flamme du chalumeau ne les brûle pas lors des travaux de soudure et de brasage sur les pièces serrées dans l'étau. Le cas échéant, recouvrez les surfaces de serrage ou l'enclume avec des matériaux résistant au feu ou à la chaleur.

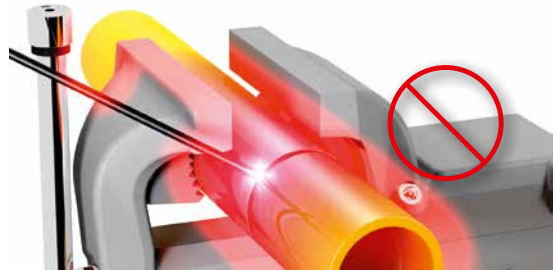

## 6. Mise au rebut

- Mettez l'étau et tous les accessoires au rebut conformément aux dispositions locales en vigueur.

## 7. Pièces de rechange et accessoires

**Pièces de rechange :**

Disponibles auprès de Hoffmann Group :  
[www.hoffmann-group.com](http://www.hoffmann-group.com)

**Accessoires :**

Dispositif de déplacement vertical, base pivotante, mors de rechange, mors de protection : voir «Catalogue Equipements d'atelier» de Hoffmann Group.

DE

EN

FR

IT

ES

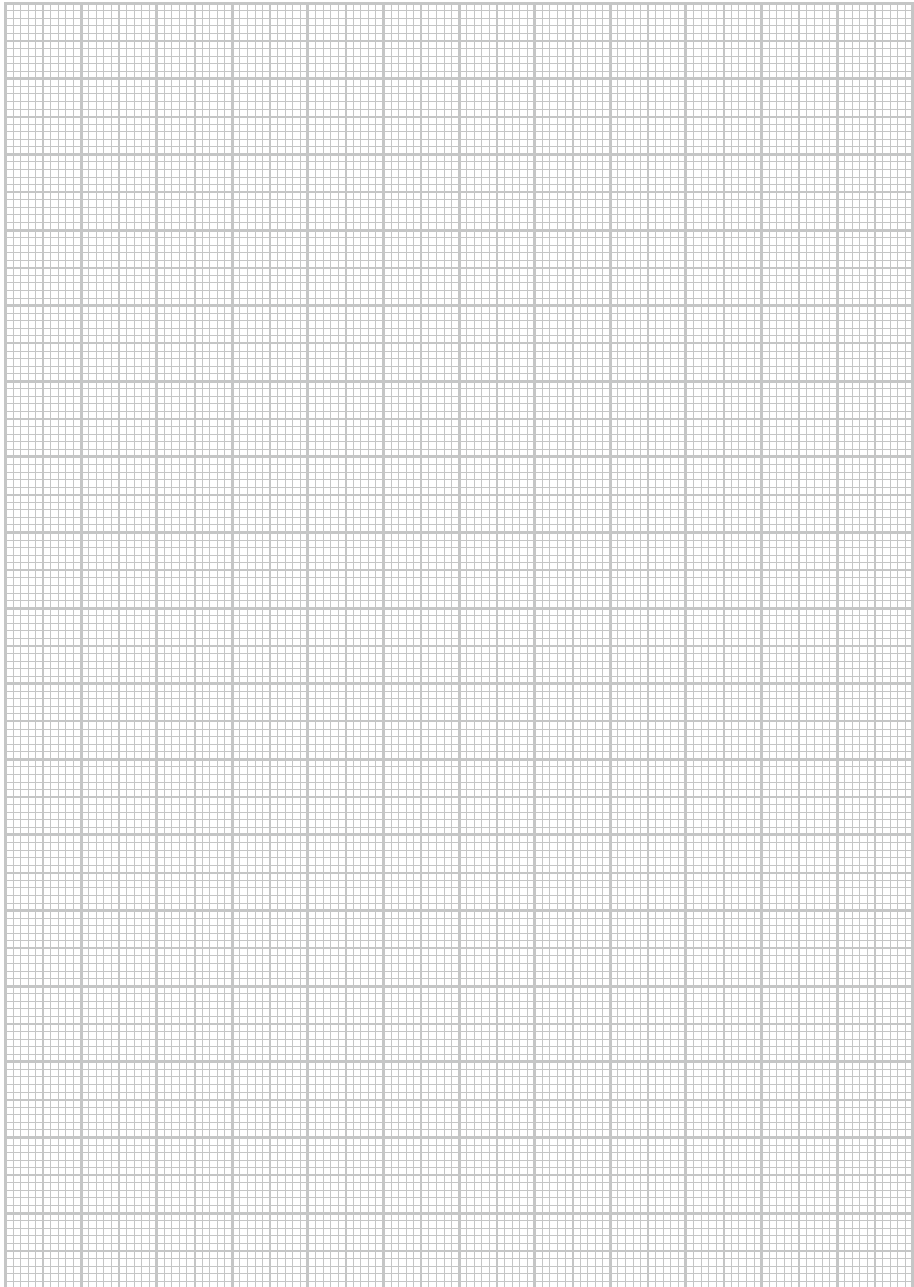

# Contenuto

1.	Informazioni sul presente documento.....	28
1.1.	Simboli e mezzi di rappresentazione.....	28
2.	Avvertenze per la sicurezza.....	29
2.1.	Trasporto e montaggio.....	29
2.2.	Destinazione d'uso.....	29
3.	Montaggio.....	29
3.1.	Utensili necessari e materiali di fissaggio.....	29
3.2. - 5	Montaggio della morsa.....	30
3.6.	Montage de la base pivotante.....	31
3.7.	Montage des mors interchangeables.....	31
4.	Smontaggio.....	32
5.	Riparazione.....	32
6.	Smaltimento.....	33
7.	Ricambi e accessori.....	33

DE

EN

FR

IT

ES



# 1. Informazioni sul presente documento

## 1.1 Simboli e mezzi di rappresentazione

### Avvertenze



Nelle presenti istruzioni vengono utilizzate avvertenze che mettono in guardia contro danni a persone e cose.

- ▶ Leggere e attenersi sempre a queste avvertenze.
- ▶ Seguire tutte le indicazioni contrassegnate con il simbolo e il termine di avvertimento.

Simbolo di avvertimento	Termine di avvertimento	Significato
	<b>PERICOLO</b>	Pericoli per le persone. La mancata osservanza causa lesioni gravi o la morte.
	<b>ATTENZIONE</b>	Pericoli per le persone. La mancata osservanza può causare lesioni gravi o la morte.
	<b>CAUTELE</b>	Pericoli per le persone. La mancata osservanza può causare lesioni lievi.
—	<b>CAUTELE</b>	Informazioni per prevenire i danni materiali e comprendere o ottimizzare le fasi di lavoro.

### Altri simboli e mezzi di rappresentazione

Per spiegare il corretto funzionamento sono state appositamente redatte importanti informazioni e avvertenze tecniche.

Simbolo	Significato
	"Nota importante"
	"Informazioni aggiuntive": Rimando ad altri documenti e informazioni
▶	Simbolo di utilizzo: È richiesto l'intervento da parte dell'operatore.

## 2. Avvertenze per la sicurezza



- ▶ Leggere le istruzioni per l'uso, seguirle, conservarle per riferimento futuro e tenerle sempre a portata di mano.

### 2.1 Trasporto e montaggio

- ▶ Utilizzare solo dispositivi di sollevamento adatti per il trasporto nel luogo previsto per l'installazione.
- ▶ Mettere in sicurezza il percorso scelto per il trasporto.



- ▶ Indossare scarpe di sicurezza e casco di protezione.





### 2.2 Destinazione d'uso

- ▶ La morsa è un dispositivo per il fissaggio dei pezzi durante la loro lavorazione.
- ▶ Perdita della garanzia:  
La morsa deve essere usata solo con la relativa chiave per asta filettata. L'uso di strumenti ausiliari, come ad esempio tubi o simili, per il serraggio non è consentito. L'uso di strumenti ausiliari non consentiti per il serraggio comporta l'immediata estinzione della garanzia.

## 3. Montaggio

### 3.1. Utensili necessari e materiali di fissaggio

- ▶ In abbinamento al piano di lavoro Hoffmann originale, spessore 50 mm.

Utensile/Materiale	100 / 120	140 / 160
	Impostare la guida: 6 mm	8 mm
	Sostituire le ganasce intercambiabili: 5 mm	6 mm
	19 mm	24 mm
 Morsa	Forare conformemente alle viti utilizzate.	
 Morsa	Per spessori inserti di 50 mm: 2×dimensioni 12 mm	4×dimensioni 16 mm
 Piastra girevole	Per spessori inserti di 50 mm: 3×dimensioni 10 mm	3×dimensioni 12 mm

### 3.2. Montaggio della morsa

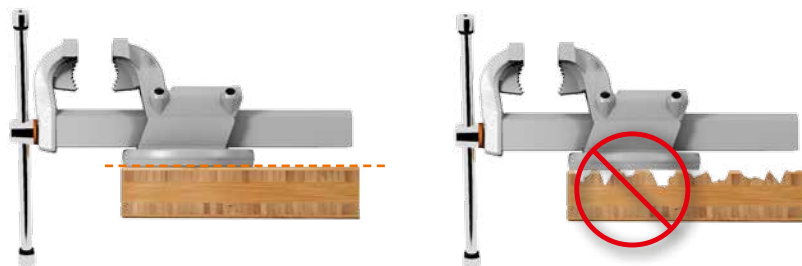

### 3.3.



### 3.4.

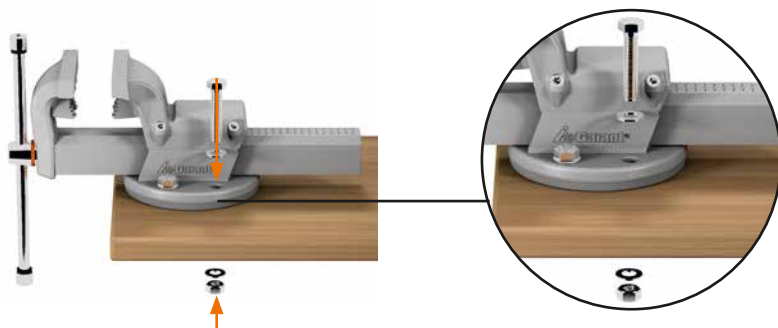

### 3.5.

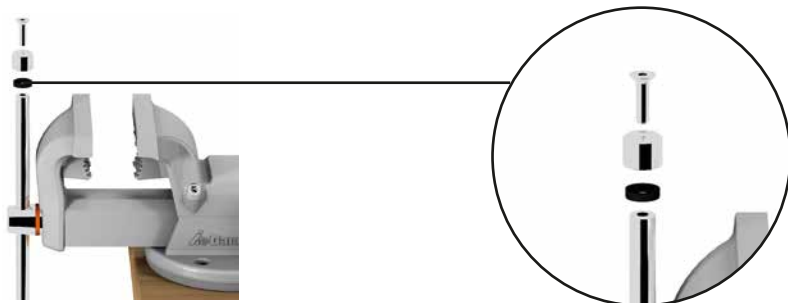

### 3.6. Montage de la base pivotante

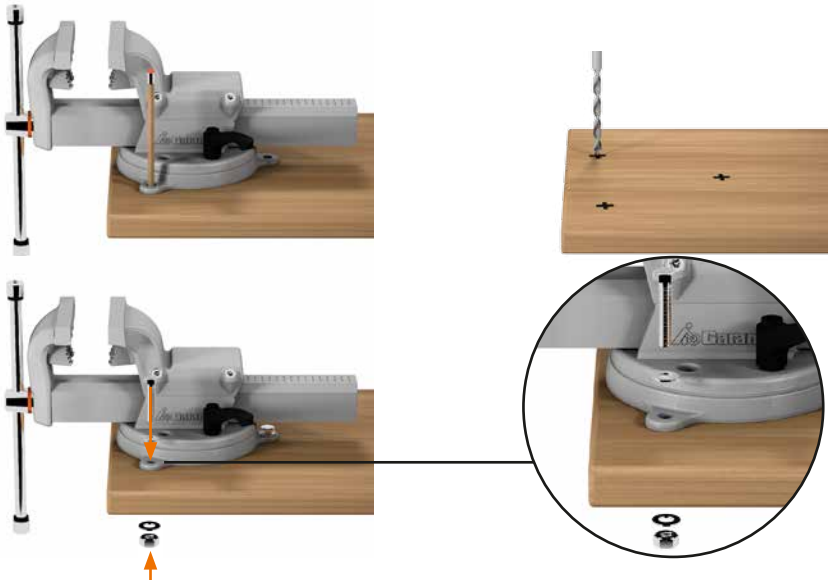

### 3.7. Montage des mors interchangeables



## 4. Smontaggio

- ▶ Rimozione dei pezzi dalla morsa.
- ▶ Per lo smontaggio della morsa, seguire la procedura inversa a quella di montaggio.

## 5. Riparazione

- ▶ Verificare con regolarità che tutti i componenti e i serraggi delle morse e della piastra girevole siano stabili, integri e perfettamente funzionanti.
- ▶ Regolazione della guida.

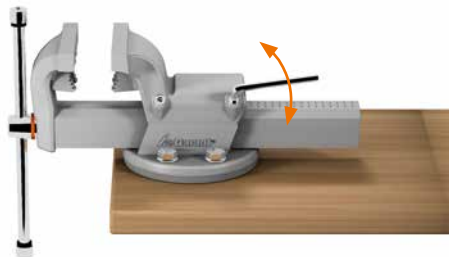

La regolazione della guida non deve mai essere rigida al punto da determinare lo spostamento **a scatti** della parte anteriore.

- ▶ Oliare periodicamente.

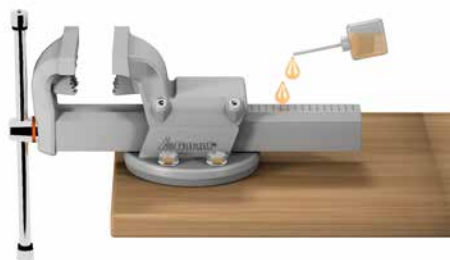





### Lavori di saldatura:

Siccome sia le superfici di serraggio delle ganasce sia l'incudine sono accuratamente temprate in superficie, per i lavori di saldatura sui pezzi serrati nella morsa è necessario fare particolare attenzione a che la fiamma del cannello non le renda incandescenti.

Se necessario, coprire le superfici di serraggio o l'incudine con materiali refrattari o resistenti alle alte temperature.

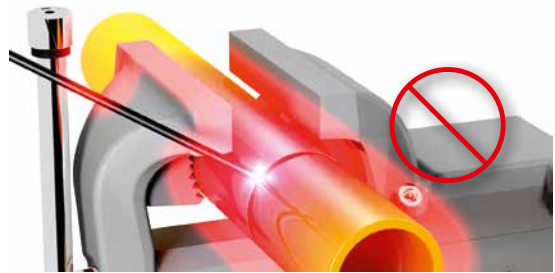

## 6. Smaltimento

- Smaltire la morsa e tutti gli accessori secondo le norme vigenti a livello locale.

## 7. Ricambi e accessori



### Ricambi:

disponibili presso Hoffmann Group: [www.hoffmann-group.com](http://www.hoffmann-group.com)

### Accessori:

dispositivo di regolazione dell'altezza, piastra girevole, ganasce di ricambio, ganasce di protezione vedi "Catalogo per l'arredamento industriale" di Hoffmann Group.

DE

EN

FR

IT

ES

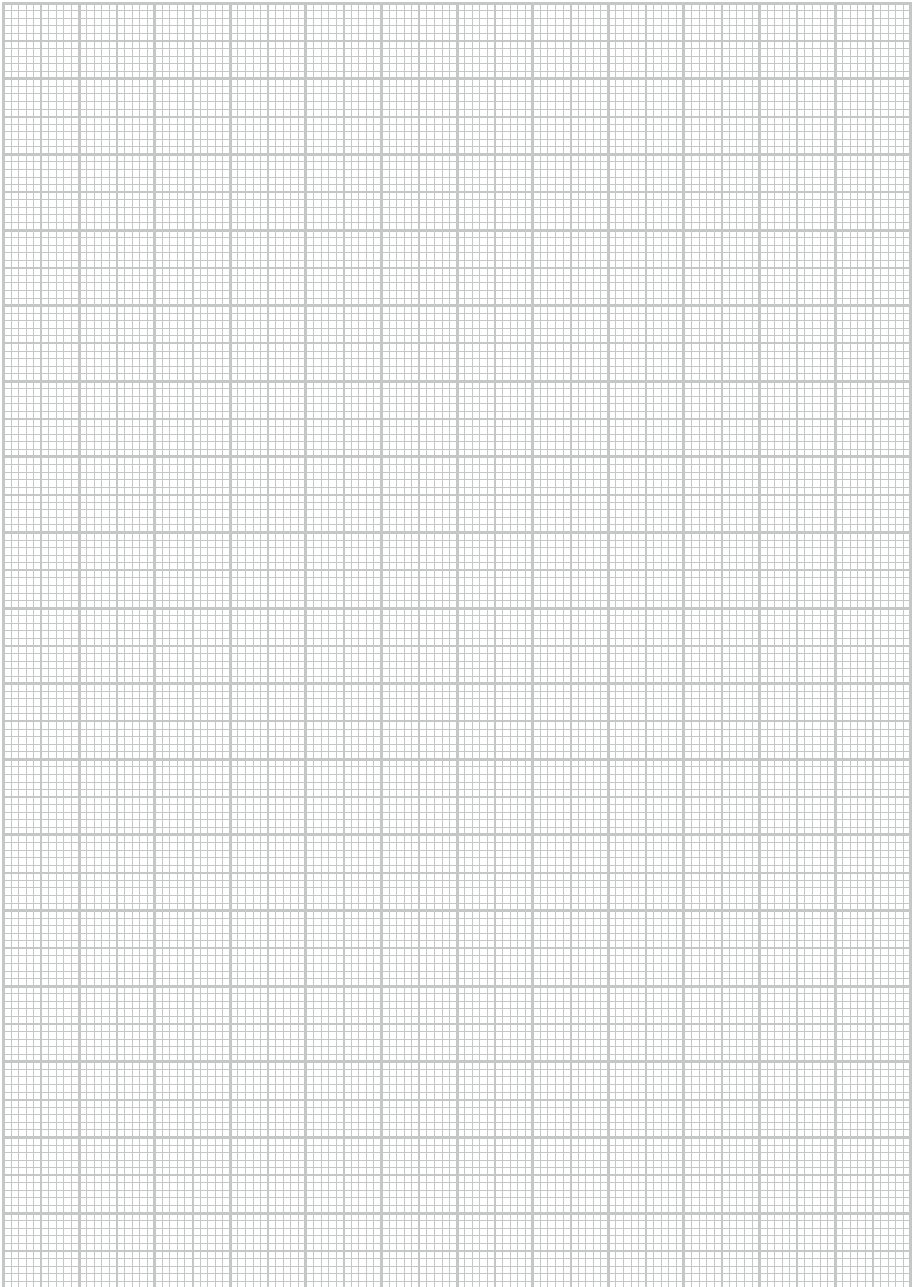

# Contenido

1.	Acerca de este documento.....	36
1.1.	Símbolos y medios de representación.....	36
2.	Indicaciones de seguridad.....	37
2.1.	Transporte y montaje.....	37
2.2.	Uso conforme a lo previsto .....	37
3.	Montaje .....	37
3.1.	Herramientas y materiales de fijación necesarios.....	37
3.2. - 5	Montaje del tornillo de banco.....	38
3.6.	Montaje de la placa giratoria .....	39
3.7.	Montaje de las mordazas cambiables .....	39
4.	Desmontaje.....	40
5.	Conservación.....	40
6.	Eliminación.....	41
7.	Piezas de repuesto y accesorios .....	41

DE

EN

FR

IT

ES



# 1. Acerca de este documento

## 1.1 Símbolos y medios de representación

### Advertencias



En estas instrucciones se utilizan advertencias para prevenirle contra daños materiales y personales.

- ▶ Lea y observe siempre estas advertencias.
- ▶ Aplique todas las medidas marcadas con el símbolo de advertencia y la palabra de advertencia.

Símbolo de advertencia	Palabra de advertencia	Significado
	PELIGRO	Peligro para las personas. La inobservancia ocasiona la muerte o lesiones graves.
	ADVERTENCIA	Peligro para las personas. En caso de inobservancia se puede producir la muerte o lesiones graves.
	PRECAUCIÓN	Peligro para las personas. En caso de inobservancia se pueden producir lesiones leves.
—	PRECAUCIÓN	Información para la prevención de daños materiales y la comprensión u optimización de los procesos de trabajo.

### Otros símbolos y medios de representación

Para ilustrar el manejo correcto, se resaltan especialmente la información importante y las indicaciones técnicas.

Símbolo	Significado
	"Nota importante"
	"Información adicional": remisión a otros documentos e informaciones
▶	Símbolo de actuación: aquí tiene que hacer algo.

## 2. Indicaciones de seguridad



- ▶ Lea, observe y conserve las instrucciones de uso para consultas posteriores, y téngalas siempre disponibles.

### 2.1 Transporte y montaje

- ▶ Utilice únicamente medios de elevación de carga apropiados para el transporte al emplazamiento.
- ▶ Asegure las vías de transporte.



- ▶ Lleve calzado de protección y casco protector.





### 2.2 Uso conforme a lo previsto

- ▶ Un tornillo de banco es un dispositivo para inmovilizar las piezas de trabajo durante su mecanizado.
- ▶ Pérdida de la garantía:  
El tornillo de banco solo se debe utilizar con su propia llave de husillo. La utilización de medios auxiliares, como tubos o similares, no está permitida en la sujeción. Si se utilizan medios auxiliares en la sujeción, se extinguirá el periodo de garantía.

## 3. Montaje

### 3.1. Herramientas y materiales de fijación necesarios

- ▶ En combinación con el tablero de trabajo original Hoffmann de 50 mm de grosor.

Herramientas / material	100 /120	140 / 160	
	Ajustar guía:	6 mm	8 mm
	Cambiar mordazas de recambio:	5 mm	6 mm
	19 mm	24 mm	
 Tornillo de banco	Taladrar previamente y de forma adecuada los tornillos utilizados.		
 Tornillo de banco	Para grosor de placa de 50 mm:	2×tamaño 12 mm	4×tamaño 16 mm
 Placa giratoria	Para grosor de placa de 50 mm:	3×tamaño 10 mm	3×tamaño 12 mm

### 3.2. Montaje del tornillo de banco

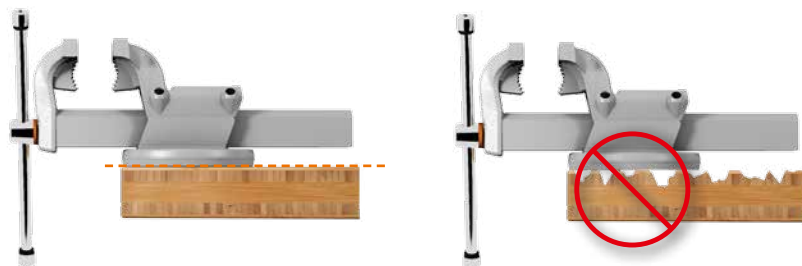

### 3.3.



### 3.4.

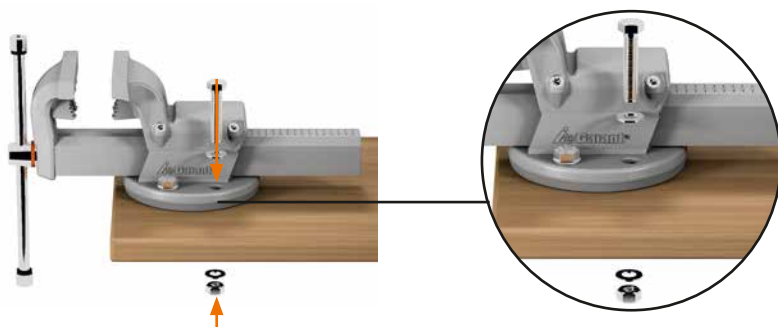

### 3.5.

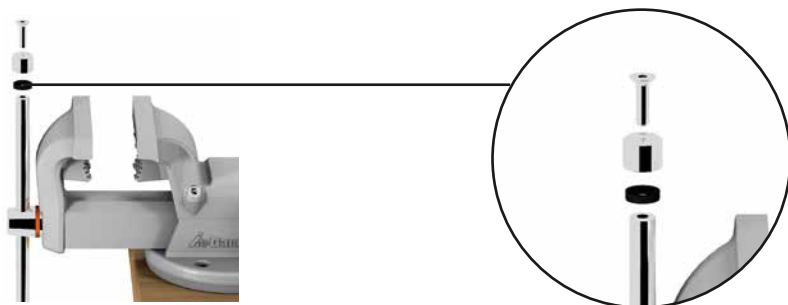

**3.6. Montaje de la placa giratoria**

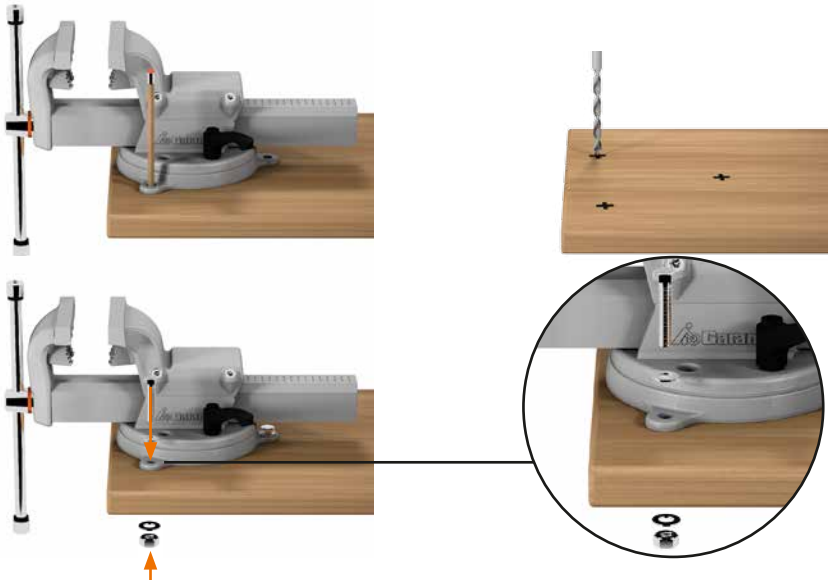

**3.7. Montaje de las mordazas cambiables**



DE

EN

FR

IT

ES

## 4. Desmontaje

- ▶ Soltar las piezas de trabajo del tornillo de banco.
- ▶ Desmontar el tornillo de banco en el orden inverso al montaje.

## 5. Conservación

- ▶ Comprobar regularmente la fijación, integridad y funcionamiento de todos los componentes y racores de los tornillos de banco y la placa giratoria.
- ▶ Reajuste de la guía.

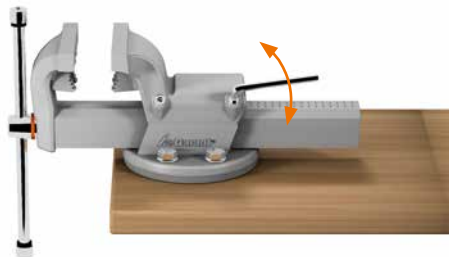

Bajo ningún concepto se podrá ajustar la guía de forma tan rígida que la parte delantera **dé golpes** al moverse.

- ▶ Lubricar regularmente.

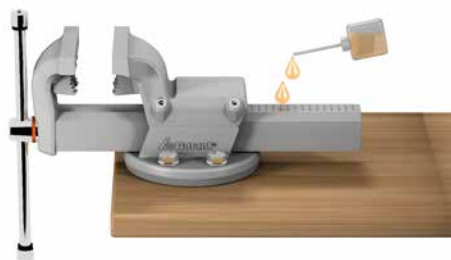





### **Soldadura:**

Dado que las superficies de apriete de las mordazas y el yunque están cuidadosamente reforzados, se ha de prestar especial atención durante el trabajo de soldadura de las piezas de trabajo que están sujetas en el tornillo de banco, para que la llama del soplete para soldar no las recueza. En caso de necesidad, cubrir las superficies de apriete o el yunque con materiales ignífugos o resistentes al calor.

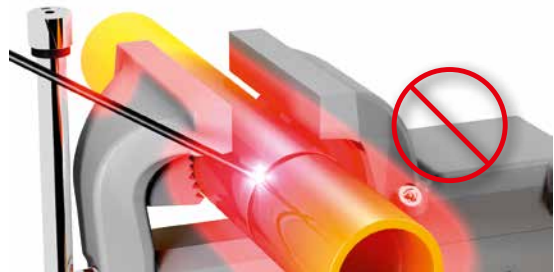

## 6. Eliminación

- ▶ Eliminar el tornillo de banco y todos los accesorios conforme a la normativa local vigente.

## 7. Piezas de repuesto y accesorios



### **Piezas de repuesto:**

disponibles a través de Hoffmann Group:  
[www.hoffmann-group.com](http://www.hoffmann-group.com)

### **Accesorios:**

Regulador de altura, placa giratoria, mordaza de recambio, mordazas protectoras, véase el "Catálogo de mobiliario industrial" de Hoffmann Group.

Hoffmann GmbH Qualitätswerkzeuge  
Haberlandstr. 55, 81241 Munich, Germany  
[www.hoffmann-group.com](http://www.hoffmann-group.com)

