

---

<b>Getting to know U.motion</b>	<b>2</b>
U.motion, a networked system	2
Design options	2
Server and touch panel: a brief introduction	2
<b>User interface</b>	<b>3</b>
Screen layout and room visualisation	3
Functional elements in the grid	3
Pop-up window	4
<b>System design</b>	<b>5</b>
Solution with U.motion KNX Server Plus	5
Solution with U.motion KNX Server	6
Solution with U.motion KNX Server Plus, Touch	7
<b>System limits and applications</b>	<b>8</b>
Client devices	8
U.motion KNX Server/Server Plus	9
Application examples	9
<b>Functions in the visualisation</b>	<b>10</b>
Functions in the navigation menu	10
Internal functions	11
<b>Data sheets</b>	<b>12</b>
U.motion KNX Server/KNX Server Plus	12
U.motion KNX Server Plus, Touch 10/15	14
U.motion Client Touch 7	16
U.motion Client Touch 10/15	18
Software specifications	20
<b>Accessories</b>	<b>22</b>
<b>U.motion door communication</b>	<b>23</b>
Intercom and door communication	23
U.motion door station set	23

### Getting to know U.motion

#### U.motion, a networked system

U.motion is a web-server-based visualisation system for house and building automation networks that have been constructed with a KNX basis. The core of the system is a server that manages the various functions of the U-motion system and the KNX installation. The functions are visualised and controlled using different "client devices":

- U.motion Client Touch panels in different sizes
- Smartphones and tablet PCs with the corresponding apps for U.motion
- Standard computers (PC/Mac) with suitable browsers

The devices can be connected to the server either through a local network or over the Internet.

U.motion links and manages the following functions:

- Controlling lighting, shading and temperature
- Energy management and load control
- Communication within the building (intercom and communication with the door station)
- Building monitoring with IP cameras
- Messages via e-mail, RSS feed, weather forecast, time synchronisation and remote control via Internet connection

The system can be expanded in many ways. From a small system with building control using smartphones and tablet PCs, through to a large system with multiple touch panels, video door stations and IP cameras, there are appropriate solutions for both residential and commercial buildings.

#### Design options

There is a uniform standard user interface for U.motion devices and it comes in two different design variants. Functions can be grouped together in different ways:

- As rooms and floors
- As functions
- As scenes
- As favourites

All the display variants are available in the default setting. If necessary, you can arrange the different variants individually. The "Functions in the visualisation" section contains an overview of the most important visualisation functions.

If multiple users use the visualisation system, it can be configured individually for each of them. Both the rooms and individual functions can be set up specifically for each user group.

End users also have the option of making individual design changes:

- Adjusting and deactivating time functions
- Changing set values for automatic functions
- Changing device values within scenes
- Individual settings via load control: changing the limits, disabling/enabling load shedding
- Positioning elements in the room visualisation
- Grouping together the most important functions as favourites

#### Server and touch panel: a brief introduction

##### Server

Depending on the system requirements and size, there is a choice of different servers:



##### U.motion KNX Server

A DIN rail device that supports a small to medium-sized KNX installation



##### U.motion KNX Server Plus

A DIN rail device that supports the functions in a larger system, including door communication

##### Touch panels with integrated server

Touch panels with the functions of a server. The benefit: all the functions are visualised and accessed directly



##### U.motion KNX Server Plus Touch 10

The touch panel has a screen diagonal of 10 inches



##### U.motion KNX Server Plus Touch 15

The touch panel has a screen diagonal of 15 inches

##### Touch panels

Touch panels call up functions and can also access the server's configuration area. The U.motion Client Touch is available in different sizes:



##### U.motion Client Touch 7

The smallest touch panel with an Android system. You can call up functions from here and also use apps. U.motion Client Touch 7 can be installed either horizontally or vertically.



##### U.motion Client Touch 10

The touch panel has a screen diagonal of 10 inches



##### U.motion Client Touch 15

The touch panel has a screen diagonal of 15 inches

# U.motion

## User interface

### User interface

#### Screen layout and room visualisation

The U.motion user interface is standardised and has a clear structure. Each page has four areas: **header line**, **navigation menu**, **user menu** and **function area**. The navigation and configuration menus can be shown or hidden.

The following example involves a **room visualisation** with a **background image** on which there is a selection of **functional elements**.



Functional element	Page area
A	Show or hide navigation menu
B	Return to home page
C	Show or hide user menu
D	One page back
E	Current page
F	Room on the same floor
G	Switch to elements positioning
H	Switch to configuration
I	Lighting switched on
J	Lighting switched off
K	Value display

You can arrange the layout of the rooms individually:

- Room visualisation with background image and active functional elements (shown here)
- Room visualisation in grid view (see next image)
  - Grid view with image (layout options: top, left, right)
  - Grid view without image
- Icons for functional elements can be chosen and labelled individually and shown with a background, if desired.
- Icons with multiple operating options are automatically displayed as a complete functional element when they are activated (see "Functional elements in the grid"). If the element is not activated, you return automatically to the icon display.
- Activating an icon for longer switches you to your favourites and time control.
- Users can move and reposition the icons on the room visualisation.

#### Functional elements in the grid

The following image shows an example of the room visualisation in a grid.

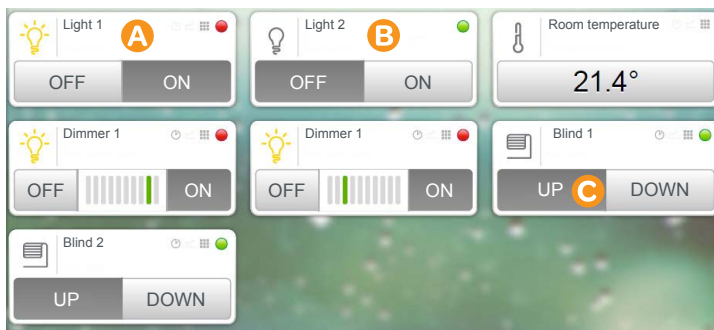

A	Lighting switched on
B	Lighting switched off
C	Button: blind moved up last
●	Status display for in or down
●	Status display for out or up
■	Functional element is component of a scene
⌚	Functional element is also time-controlled

Functional elements in the grid provide a clear structure to the functional area. They can be used either for **room visualisations** or for **functional visualisations**. The functional elements show values, status and assignment to scenes, time control and energy curves.

**Functional pages** are organised by subject (e.g. lighting). **Room visualisations** are normally used to display and control different functions together as a group (e.g. lighting, blinds and room temperature).

### Pop-up window

For complex functions, additional pop-up windows can be called up via a functional element or a navigation menu:



### Weather forecast

The pop-up window is opened via the **navigation menu**.

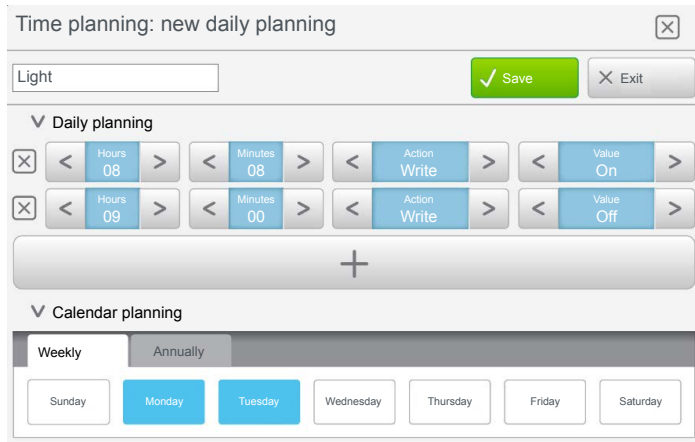

### Time planning

Time planning can also be activated for all elements that are controlled using a visualisation. The pop-up menu is called up via the **functional element**

# U.motion System design

## System design

There are essentially three extensions for the U.motion visualisation system:

- Solution with **U.motion KNX Server Plus**
- Solution with **U.motion KNX Server**
- Solution with **U.motion KNX Server Plus, Touch**

U.motion is a web-server-based visualisation system for house and building automation networks that have been constructed with a KNX basis. The core of the system is a server that manages the various functions of the U-motion system and the KNX installation. The functions are visualised and controlled using different "client devices":

- U.motion Client Touch panels in different sizes
- Smartphones and tablet PCs with the corresponding apps for U.motion
- Standard computers (PC/Mac) with suitable browsers

The server is configured directly on its web interface in a browser. It can also be configured offline using the U.motion Builder, which is available free of charge.

The following sections describe the system limits and applications of each server, as well as an overview of the visualisation functions. The section on the U.motion door communication describes how the intercom is connected to door stations.

### Solution with U.motion KNX Server Plus

The following client devices can use the Server Plus as a master:

- U.motion Client Touch 7
- U.motion Client Touch 10
- U.motion Client Touch 15
- Smartphones
- Tablet PCs
- Devices with a suitable browser (PCs and Macs)

The following technologies are grouped together in the visualisation system:

- KNX building automation
- Monitoring with IP cameras
- Intercom between internal devices
- Door communication between internal devices and door stations
- Internet services, e.g. RSS news, weather forecast and system e-mails
- Family board for messages to the display devices

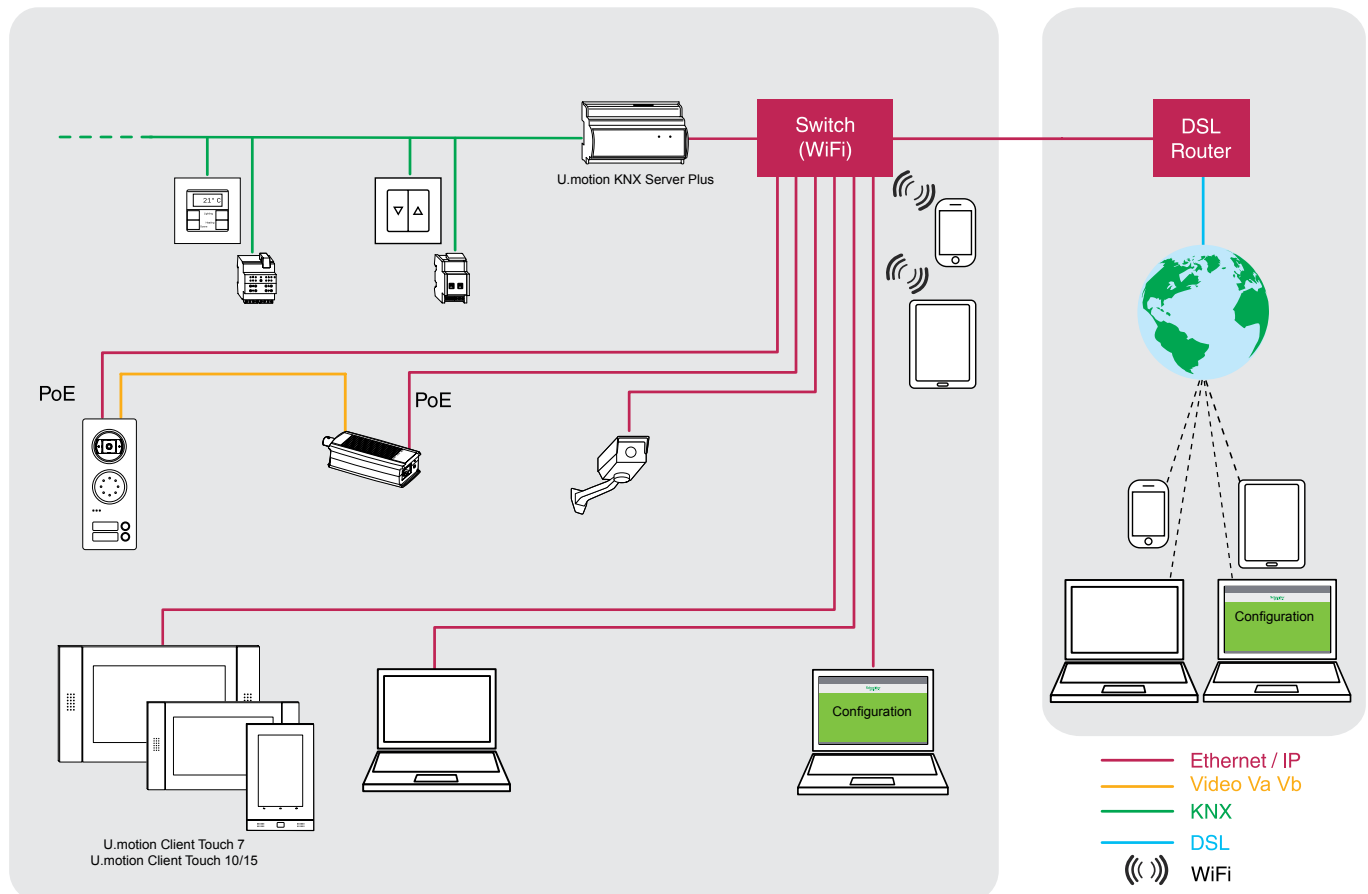

## Solution with U.motion KNX Server

The following client devices can use the Server as a master:

- U.motion Client Touch 7
- Smartphones
- Tablet PCs
- PCs\* or Macs\*

The following technologies are grouped together in the visualisation system:

- KNX building automation
- Monitoring with IP cameras
- Internet services, e.g. RSS news, weather forecast and system e-mails
- Family board for messages to the display devices

\* two hour time limit after logging on for PCs and Macs

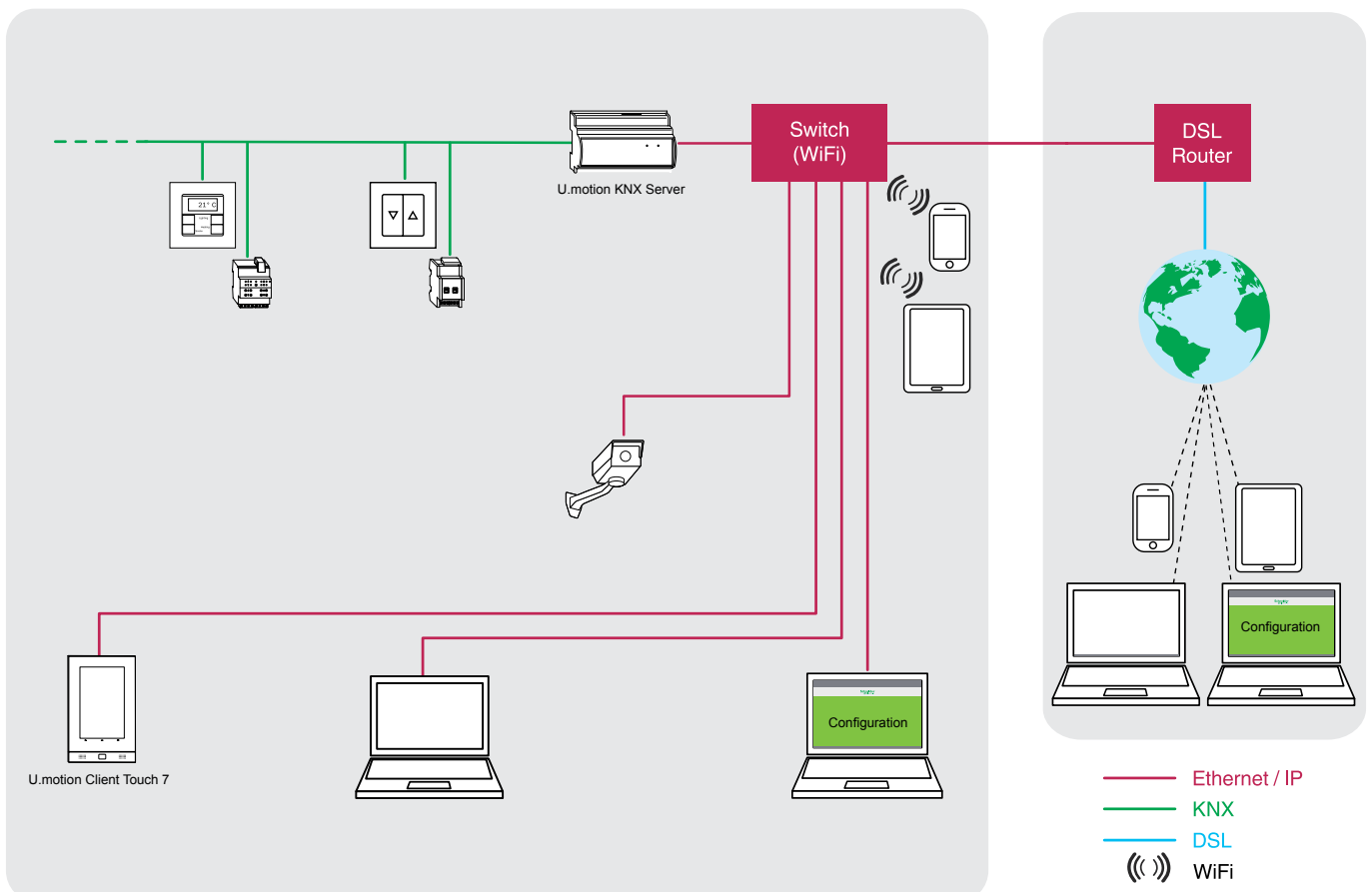

# U.motion System design

## Solution with U.motion KNX Server Plus, Touch

The following client devices can use the Server Plus as a master:

- U.motion Client Touch 7
- Smartphones
- Tablet PCs
- PCs\* and Macs\*

The following technologies are grouped together in the visualisation system:

- KNX building automation
- Monitoring with IP cameras
- Intercom between internal devices
- Door communication between internal devices and door stations
- Internet services, e.g. RSS news, weather forecast and system e-mails
- Family board for messages to the display devices

\* two hour time limit after logging on for PCs and Macs

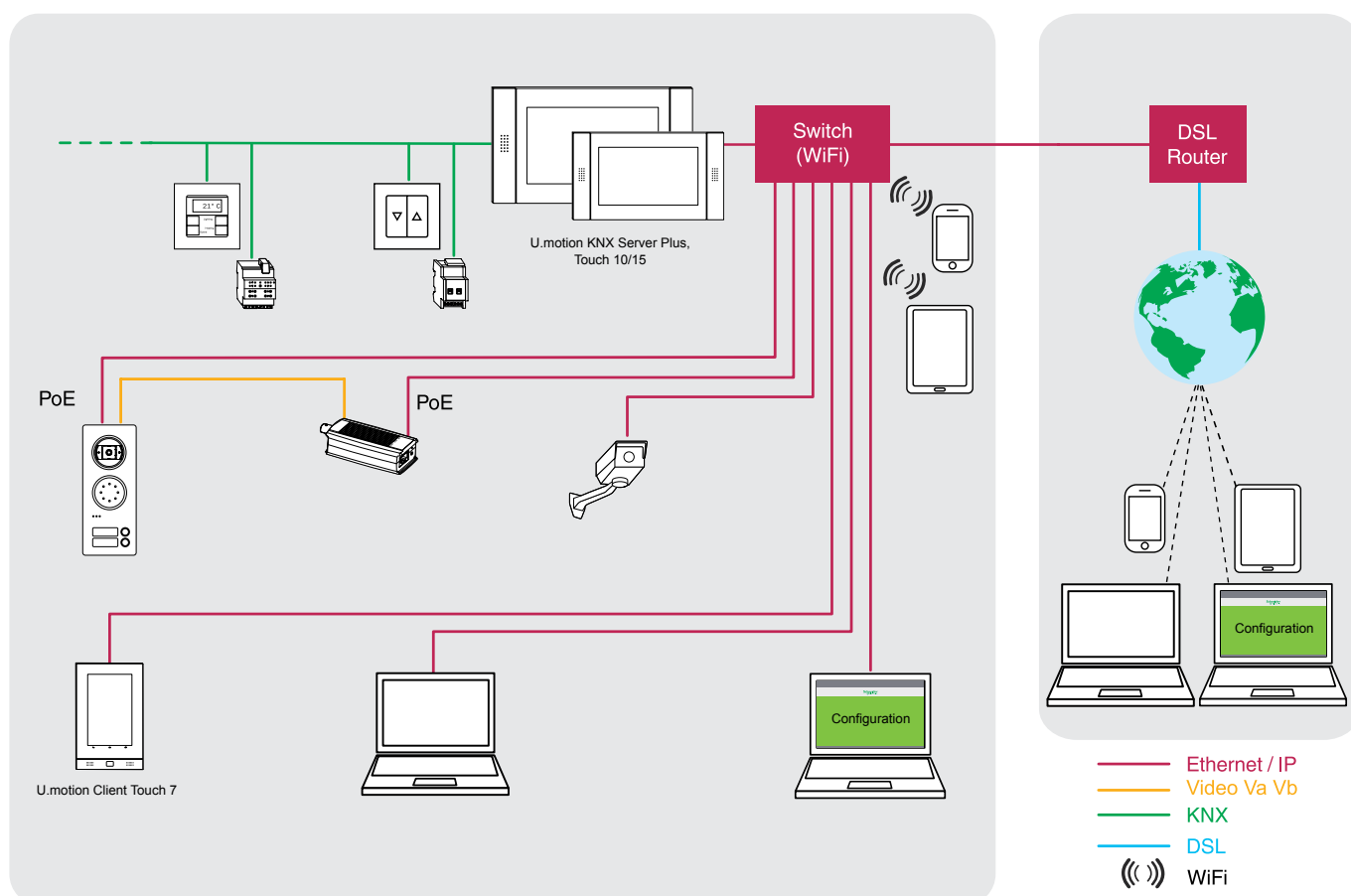

## System limits and applications

### Client devices

The following describes which devices are connected to the server via **browser technology** and which are connected via **apps**. There is also an overview of client devices can be used for each server.

#### Browsers

Browsers are used to configure the server and for the entire visualisation process. Standard computers (PC/Mac) with the following browsers are fully compatible:

- Google Chrome™
- Apple Safari®.

#### Apps

The following U.motion apps are available for the visualisation and to control server functions:

- **U.motion Control** for building control and video monitoring
  - App for smartphones and tablet PCs (devices with Android or iOS operating system)
  - App included with U.motion Client Touch 7
- **U.motion Communication** for intercom and door communication
  - App for smartphones and tablet PCs (for devices with Android operating system)
  - App included with U.motion Client Touch 7

### Client devices per server

	U.motion KNX Server	U.motion KNX Server Plus	U.motion KNX Server Plus Touch
<b>Local access to visualisation</b>			
■ Via PC/Mac, U.motion Client Touch 10/15	unlimited* (limited to two hours)	unlimited*	unlimited* (limited to two hours)
■ Via apps, U.motion Client Touch 7	unlimited*	unlimited*	unlimited*
<b>Remote access to visualisation</b>			
■ Via PC/Mac	unlimited* (limited to two hours)	unlimited*	unlimited* (limited to two hours)
■ Via apps	unlimited*	unlimited*	unlimited*
<b>Local access to configuration</b>			
■ Via PC/Mac, U.motion Client Touch 10/15	unlimited*	unlimited*	unlimited*
■ Via apps, U.motion Client Touch 7	No	No	No
<b>Remote access to configuration</b>			
■ Via PC/Mac	unlimited*	unlimited*	unlimited*
■ Via apps	No	No	No

\*Unlimited means that there are no physical restrictions on the number of client devices. However, if more than 20 client devices access the server simultaneously, the server's response time might slow down. This does not include devices on standby.



# U.motion

## System limits and applications

### U.motion KNX Server/Server Plus

Below is a list of the technical limits and differences between the individual U.motion KNX servers.

Area	Functions	U.motion KNX Server Plus U.motion KNX Server Plus, Touch	U.motion KNX Server	Remarks
General	Rooms and areas	unlimited	10	Rooms and areas can be configured in addition to the default function pages.
KNX	Group addresses	1000	150	Group addresses can be used multiple times. Virtual objects for displaying functions that are calculated internally are not considered a group address.
	Scenes	50	5	Scenes can be configured in addition to the KNX scenes (no group address).
	Logical links	100	5	A link can be used to link multiple inputs in multiple stages.
	Conditions	100	5	Conditions can refer to values and value ranges.
Energy efficiency and load management	Energy counter	10	1	The energy counter is always based on the power measured or calculated at the present time. The individual values can be saved, calculated and displayed in graphs.
	Loads	30	4	Depending on the configuration of the energy counter, loads can be switched on and off.
Video monitoring	IP cameras	unlimited	2	See video monitoring function
Intercom	Door stations	3	None	See section on U.motion door communication
	Call groups	3	None	A call group includes all the devices and users in the U.motion system who are reached via a bell push-button.
	Internal connections	10	None	This includes U.motion Client Touch 7 and mobile devices with an intercom and door station app. When the U.motion KNX Server Plus is used further connections via U.motion Client Touch 10/15 and PCs/Macs can be set up.

### Application examples

The differences in the quantity structure and function scope described above result in different possible uses for each server. The number of rooms is calculated on the basis of how many group addresses experience shows are needed for each room; however, this may be altered in specific cases.

The choice between U.motion KNX Server Plus and U.motion KNX Server Plus Touch mainly depends on which client devices are to be used. If you want to use standard computers (PC/Mac) and U.motion Client Touch 10/15 permanently, you need a U.motion KNX Server Plus.

U.motion KNX Server Plus U.motion KNX Server Plus, Touch	U.motion KNX Server
<b>Residential buildings</b> <ul style="list-style-type: none"> <li>25 rooms</li> <li>Room temperature control and blinds</li> <li>Dimmers and RGB light</li> <li>IP cameras</li> <li>Building communications</li> <li>Energy monitoring</li> </ul>	<b>Single-family home</b> <ul style="list-style-type: none"> <li>8 rooms</li> <li>Room temperature control and roller shutters</li> <li>Switching</li> <li>Tablet PCs and smartphones</li> </ul>
<b>Office buildings</b> <ul style="list-style-type: none"> <li>40 rooms</li> <li>Room temperature control and roller shutters</li> <li>LED lighting</li> <li>Window and smoke detector contacts</li> </ul>	<b>Shop</b> <ul style="list-style-type: none"> <li>8 rooms</li> <li>Room temperature control and roller shutters</li> <li>Switching</li> <li>Controlling cooling via e-mail</li> <li>Smoke detector contacts</li> </ul>
<b>Private school</b> <ul style="list-style-type: none"> <li>25 rooms</li> <li>Room temperature control and blinds</li> <li>Light control</li> <li>Solar plant and energy monitoring</li> <li>IP cameras</li> </ul>	<b>Small hotel</b> <ul style="list-style-type: none"> <li>8 rooms</li> <li>Room temperature control and roller shutters</li> <li>Switching</li> <li>IP camera at entrance</li> <li>U.motion Client Touch 7</li> </ul>

### Functions in the visualisation

The navigation menu on the home page of the visualisation contains the functions described below. Depending on the project, you can also hide functions that are not needed. The logic, conditions and integrators are internal functions for further processing of input data.

#### Functions in the navigation menu



##### Rooms and floors

Rooms are used to control different **room functions**. An example of a room visualisation is shown above. You can navigate from room to room by clicking on the relevant buttons. Overviews of floors with visible or transparent buttons for other rooms can also be set up.

There is a wide variety of **design variants** for the room visualisation. In addition to rooms with objects on a background image, there are visualisations with functional elements in a grid (see section on screen layout and room visualisation). You can also display static images and video images from IP cameras to match the room.

The functions can be grouped together from all areas. In addition to KNX basic functions (lighting, shading, temperature control), you can display measured values, limit values, logically linked values and scenes.

To provide a better overview, pop-up windows can be opened via a button for some elements (see above). Examples: thermostat, RGB lights, weather forecast.

The end user can set, activate and deactivate time switch functions for controllable objects (day, week, year).



##### Functions

The functional visualisation is an **extension of the room visualisation**. It is used to arrange objects by area, such as lighting, heating and air-conditioning, shading, energy management or weather.

Objects that have already been assigned a function for the room visualisation (e.g. lighting) automatically appear in the corresponding functional visualisation. To improve clarity, however, it is possible to make entire functional areas or individual functional objects invisible.



##### Scenes

Scenes **group together** different **single functions** within the visualisation and save them on the server.

A scene is used to simultaneously call up multiple actions that are appropriate to a particular use of the room or building. As with KNX scenes, end users can change the values and **save them again**, if necessary.

The actions can also be started after a delay. To do this, **wait times** of one second to 24 hours are configured. One example of a simple application is activating corridor lighting for when you leave the building.

Scenes can also be activated via the **time planning**. The end user can freely change the times and disable or enable the scene.

Scenes can be called up from the scene page or from the room pages. A **scene icon** is displayed on functional elements that are linked to scenes to inform the end user (see above: Functional elements in the grid).

In addition to the scenes described here, KNX scenes can also be visualised. In KNX scenes, all the scene values are stored in the KNX devices and can be called up in the visualisation using KNX scene telegrams (1 byte).

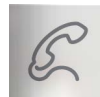

##### Intercom

The intercom function enables audio and video communication via the IP network, either **between different terminal units** or with **door stations**.

In order to use intercom functions, a suitable U.motion server needs to be installed:

- U.motion KNX Server Plus
- U.motion KNX Server Plus, Touch

Intercom functions can be used on the following devices:

- U.motion Client Touch 10
- U.motion Client Touch 15
- U.motion KNX Server Plus, Touch
- U.motion Client Touch 7
- PC/Mac with suitable browser with VoIP JAVA support
- Smartphones and tablet PCs with Android operating system

The **U.motion Communication app** is included in the scope of delivery for U.motion Client Touch 7 and is also available for devices with the Android operating system (Google Play™ Store).

When the U.motion user interface is used, bidirectional audio communication is possible. VoIP communication requires the software and hardware of third-party devices to comply with the SIP standard.

**Door communication** can be configured with a U.motion door station set. Besides the camera in the door station, further IP cameras can be added and accessed in door communication. There is an overview of the installation in the section on U.motion door communication.



##### Video monitoring

Video images from IP cameras can be linked to the visualisation on room and functional pages. It is also possible to integrate IP cameras into the door communication.

The following devices can receive and display video images:

- U.motion Client Touch 7/10/15
- U.motion KNX Server Plus, Touch 10/15
- PC/Mac with browser with JAVA support
- Smartphones and tablet PCs with Android or iOS operating system

Individual JPG images from an IP camera or a video server can be called up (**generic (M) JPG**). In this case, the U.motion server updates the images at the speed allowed by the network. This method can be used for numerous cameras or video servers that provide a path to the still image.

# U.motion

## Functions in the visualisation



### Energy management and load control

The **energy consumption** of one or more **counters** can be shown as a graph and linked to a **load control**. When the energy counter's threshold value is exceeded, loads can be automatically switched off in order of assigned priority. Instead of consumption, it is also possible to display energy generated (e.g. via photovoltaics). These measurements are based on the **load values** received via KNX objects. Optionally, power can also be calculated as **current** and **voltage values**.

A **counter** shows the current power. The colours green, orange or red indicate whether the upper and lower limit values have been exceeded.

It is also possible to activate a diagram that displays consumption over a specific period of time. You can choose from the following time frames: "Today", "Yesterday", "Week", "Last week", "Month", "Last Month", "Year", "Last year".

For example, the "Yesterday" display shows consumption for each hour as a bar. The day's total consumption is also shown as a numerical value.

You can also show **comparison data** for the selected time frame. The comparison data is calculated from data collected previously and is shown as average values appropriate to the current data. Data for the comparative daily display is stored for a maximum of 15 days while data for the annual display is stored for a maximum of 10 years.

In **load control**, one or more loads are assigned to a counter. If automatic load control is activated, loads are switched off when the upper limit value is exceeded and switched on again when the value drops below the lower limit. If there are multiple loads, you can assign **priority values** to specify the order in which the loads are switched off. You also have the option of disabling automatic load switching for any load (**manual operation**).



### Notification

Notifications are messages forwarded via a U.motion server to one or more recipients when specific events occur. Notifications can be sent by **e-mail** or as an **on-screen message**.

E-mails are sent to the specified recipients via a configured, external **SMTP server**.

On-screen messages are displayed within the visualisation and appear as a new entry in the "Central – notifications" **pop-up window**.

Notifications are triggered by **events** that are linked to correspondingly configured objects. For example, the object "overheating" can trigger a notification if the value "1" is received. "Virtual objects" also make it possible to link multiple relationships together.

E-mail notifications are re-sent each time the trigger condition is met.

On-screen messages are indicated accordingly on the menu button and in the pop-up window. The number of unread messages is shown on the menu button. If necessary, these can be marked as read or deleted. On-screen messages can be linked to different priorities. In the default setting, only messages of the type "alarm" **automatically open** the pop-up window. "Warnings" and "information" are only marked and have to be accessed manually. The "Central – notifications" pop-up window also takes you to the **family board** (see next function).



### Family board

The family board makes it possible to enter **messages** directly onto a touch screen **manually**. It can also be accessed via the "Central – notifications" pop-up window. After you complete the message, the family board icon appears as an additional menu button.

Messages on the family board are only displayed **locally** on the device on which they were entered.



### Weather

The weather menu button opens a pop-up window. This window contains the **current weather data** and the **weather forecast** for the configured location over the next few days.

If a **weather station** or suitable sensors are available, further weather data can be displayed after the relevant settings are configured. Possible data include the current brightness outside and wind or rain alarms.



### RSS news

RSS feeds can be used to access messages from the Internet. An RSS feed refers to the provision of data in the RSS format. This involves Internet services that the U.motion server accesses at regular intervals for updates. Up to **5 RSS services** can be configured. To configure them, all you need is the feed URL for the provider in question.

## Internal functions

### Logic



The logic operations **AND** and **OR** are available for further processing of input data. Inverting the output values also gives us the links **NAND** and **NOR**. If the logic result is only used within the visualisation, a **virtual object** can be configured for display. However, the output cannot be linked to **KNX objects** or **scenes**.

A typical application is grouping together individual messages into a group message. .

### Conditions



Conditions are objects that **compare** values between one or more objects and that can start **events**. Conditions: Greater than / greater than or equal to / less than / less than or equal to / equal to / within the values (including or excluding extremes) / outside the values (including or excluding extremes)

Example:

The temperature is compared to a value. If it is exceeded, a **virtual object** (e.g. overheating) is set to the value "1" and displayed on the relevant room page. A message can also be sent, if desired.

### Integrators



Integrators make it possible to **calculate** the integral of the values of objects over a specific **time period**.

Example:

An operating hours counter for a light is created using an integrator and compared against a limit value (condition). If the limit value is exceeded, a message is generated and visualised.

Data sheets



U.motion KNX Server/KNX Server Plus

The U.motion KNX Server/Server Plus is a web-based visualisation system for home and building automation based on KNX. The server acts as master and allows the control of the KNX devices through U.motion Client Touches, smartphones, tablet PCs, and any kind of device (PC/MAC) with a working browser. The remote access to the visualisation is possible with a smartphone, tablet PCs or any standard computer with a working browser (PC/MAC).

The configuration and use of this server takes place directly through its web interface, which can be accessed through a conventional browser. The customisable graphical interface with different themes is optimised for visualisation on different mobile and fixed devices. There are various extension possibilities thanks to functions like scenarios, time scheduling, logics, conditions, integrators, virtual objects, complexe objects, notifications on screen and by e-mail, IP cameras, as well as support for VoIP integrations (VoIP is only available for the U.motion KNX Server Plus). The configuration is possible directly on the server and offline via the U.motion Builder (available for free).

Technical data	U.motion KNX Server Art. no. MTN6501-0001	U.motion KNX Server Plus Art. no. MTN6501-0002
<b>Hardware Specifications</b>		
Power supply	DC 12 ... 24 V Connector with screw connections. Input with polarity protection	
Power Consumption	3 W (240 mA at 12 V)	
Interfaces	KNX Connector with screw connections. Input with polarity protection LAN (1x) RJ45 interface (10/100 Mbps)	
Storage extension	SD/SDHC up to 32 GB	
Reset	Hardware button on lower side of case	
LED	1x Red = Reset running / Error 1x Green = Operation LED	
Protection grade	IP 20 (following EN 60529)	
Temperature range (usage)	0 °C ... +50 °C	
Authorization	CE	
Dimensions [mm] (Length x Height x Width)	161 x 95 x 63	
Device width [mm]	9 modules	
Installation site	For installation on DIN rails TH35 according to EN 60715.	
Material	Auto-extinguishing plastic case (AE)	
<b>System properties</b>		
KNX group addresses	150	1000
Scenarios	5	50
Logics	5	100
Conditions	5	100
Areas/Rooms/Pages	10	Unlimited
Energy management	Energy counters: 1 Loads: 4	Energy counters: 10 Loads: 30
IP-cameras (MJPEG)	2	Unlimited
Intercom functionality	—	yes

# U.motion

## Data sheets

Technical data	U.motion KNX Server Art. no. MTN6501-0001	U.motion KNX Server Plus Art. no. MTN6501-0002
<b>System access</b>		
Local access to the visualisation area		
■ via PC/MAC, U.motion Client Touch 10/15	Unlimited* The access is limited timewise to 2 hours.	Unlimited*
■ via mobile Apps, U.motion Client Touch 7	Unlimited*	Unlimited*
Remote access to the visualisation area		
■ via mobile Apps	Unlimited*	Unlimited*
■ via PC/MAC	Unlimited* The access is limited timewise to 2 hours.	Unlimited*
Local access to the configuration area		
■ via PC/MAC, U.motion Client Touch 10/15	Unlimited*	Unlimited*
■ via mobile Apps, U.motion Client Touch 7	—	—
Remote access to the configuration area		
■ via mobile Apps	—	—
■ via PC/MAC	Unlimited*	Unlimited*

\* Note: The number of connected U.motion client devices is physically not limited. However, more than 20 simultaneously executed accesses from client devices (devices in idle state not included) could slow down the response time of the system.



## U.motion KNX Server Plus, Touch 10/15

The U.motion KNX Server Plus Touch 10/Touch 15 is a web-based visualisation system for home and building automation based on KNX. The server act as master and allows the control of the KNX devices through its own screen, U.motion Client Touches, smartphones, tablet PCs, and any kind of device (PC/MAC) with a working browser. The remote access to the visualisation is possible with a smartphone, tablet PCs or any standard computer with a working browser (PC/MAC).

The configuration and use of this server takes place directly through its web interface, which can be accessed through a conventional browser. The customisable graphical interface with different themes is optimised for visualisation on different mobile and fixed devices. There are various extension possibilities thanks to functions like scenarios, time scheduling, logics, conditions, integrators, virtual objects, complexe objects, notifications on screen and by e-mail, IP cameras, as well as support for VoIP integrations. The configuration is possible directly on the server and offline via the U.motion Builder (available for free).

Technical data	U.motion KNX Server Plus Touch 10 Art. no. MTN6260-0410	U.motion KNX Server Plus Touch 15 Art. no. MTN6260-0415
Type of design	An ultra compact embedded touch panel for wall mounting <ul style="list-style-type: none"> <li>■ noiseless and without any rotating parts</li> <li>■ homogeneous smooth glass surface with aluminium side border</li> </ul>	
<b>Software</b>		
Operating system	Linux	
<b>Front Unit</b>		
Size	25.6 cm (10.1") widescreen	39.6 cm (15.6") widescreen
Type	LED backlight TFT	LED backlight TFT
Luminosity	200 cd/m <sup>2</sup>	300 cd/m <sup>2</sup>
Contrast	400:1	500:1
Resolution (in Pixel)	WSVGA 1024x600	WXGA 1366x768
MTBF backlight	30,000 h	50,000 h
Method of operating	Projected capacitive touch screen with 3 mm glass front, dual touch capable	
Protection class	IP20 according EN 60529	
<b>General characteristics</b>		
Processor	Fanless ultra low consumption	
Memory	1 GB DDR2 SDRAM	
Power Supply	100 – 240 VAC	
Power consumption	Max. 20 W	Max. 25 W
<b>Interfaces</b>		
LAN/Ethernet	1 x 10/100/1000 Mbps (ext)	
USB	4 x USB 2.0 (1x front accessible, 3x back accessible)	4 x USB 2.0 (2x front accessible, 2x back accessible)
Multimedia	Speaker and microphone included with echo cancellation	
Expansions	KNX Interface	
<b>Ambient Conditions</b>		
Vibration/Shock resistance	15 G/50 G	
Temperature range (usage)	+0 °C to +30 °C max.	
Authorization	CE	
<b>Dimensions</b>		
Product size [mm] (Length x Height x Width)	343 x 201 x 81	525 x 306 x 92
Product size with Design element [mm] (Length x Height x Width)	349 x 201 x 81	531 x 306 x 92
Weight	2.2 kg	6 kg

# U.motion

## Data sheets

Technical data	U.motion KNX Server Plus Touch 10 Art. no. MTN6260-0410	U.motion KNX Server Plus Touch 15 Art. no. MTN6260-0415
<b>Mechanical Characteristics</b>		
Mounting	One man mounting system with Schneider Electric mounting boxes:	
	<ul style="list-style-type: none"> <li>■ U.motion Touch 10 Flush mounting box (Art. no. MTN6270-5004)</li> <li>■ U.motion Touch 10 Cavity wall set (Art. no. MTN6270-5005)</li> <li>■ U.motion Touch 10 Cavity wall set, flush mounting (Art. no. MTN6270-5006)</li> </ul>	<ul style="list-style-type: none"> <li>■ U.motion Touch 15 Flush mounting box (Art. no. MTN6270-5007)</li> <li>■ U.motion Touch 15 Cavity wall set (Art. no. MTN6270-5008)</li> <li>■ U.motion Touch 15 Cavity wall set, flush mounting (Art. no. MTN6270-5009)</li> </ul>
Orientation	For horizontal installation	
Front	Full glass front with Aluminium Side Cover. The glass front has a black border.	
<b>System properties</b>		
KNX group addresses	1000	
Scenarios	50	
Logics	100	
Conditions	100	
Areas/Rooms/Pages	Unlimited	
Energy management	Energy counters: 10 Loads: 30	
IP-cameras (MJPEG)	Unlimited	
Intercom functionality	yes	
<b>System access</b>		
Local access to the visualisation area		
<ul style="list-style-type: none"> <li>■ via PC/MAC, U.motion Client Touch 10/15</li> <li>■ via mobile Apps, U.motion Client Touch 7</li> </ul>	Unlimited* - The access is limited timewise to 2 hours. Unlimited*	
Remote access to the visualisation area		
<ul style="list-style-type: none"> <li>■ via mobile Apps</li> <li>■ via PC/MAC</li> </ul>	Unlimited* Unlimited* - The access is limited timewise to 2 hours.	
Local access to the configuration area		
<ul style="list-style-type: none"> <li>■ via PC/MAC, U.motion Client Touch 10/15</li> <li>■ via mobile Apps, U.motion Client Touch 7</li> </ul>	Unlimited* —	
Remote access to the configuration area		
<ul style="list-style-type: none"> <li>■ via mobile Apps</li> <li>■ via PC/MAC</li> </ul>	— Unlimited*	
<b>Accessories</b>		
Aluminium Side Cover	<ul style="list-style-type: none"> <li>■ U.motion Touch 10 Design element (Art. no. MTN6270-4160)</li> </ul>	<ul style="list-style-type: none"> <li>■ U.motion Touch 15 Design element (Art. no. MTN6270-4260)</li> </ul>

\* Note: The number of connected U.motion client devices is physically not limited. However, more than 20 simultaneously executed accesses from client devices (devices in idle state not included) could slow down the response time of the system.



## U.motion Client Touch 7

U.motion Client Touch 7 visualises and controls the current building conditions provided by a U.motion KNX Server/KNX Server Plus as well as the functions of the U.motion system.

These functions include:

- Control of lighting, blinds and room temperature-control of a KNX system
- Communication inside a building (intercom, communication to the door station)
- Monitoring of the building with IP cameras

U.motion Client Touch 7 uses the Android operating system. Due to this, visualisation will run as an Android-App on U.motion Client Touch 7. With the App U.motion Access it is possible to configure the most used Apps on the front-page, e.g. the App U.motion Control (control KNX installation) and U.motion Communication (for Intercom).

Technical data	U.motion Client Touch 7 Art. no. MTN6260-0307 Version 2
Type of design	Ultra compact embedded touch panel for wall mounting; an open system for your applications; noiseless and without any rotating parts
<b>Software</b>	
Operating system	Android
<b>Front Unit</b>	
Size	17.78 cm (7") widescreen - LED backlight TFT
Type	LED backlight TFT
Luminosity	500 cd/m <sup>2</sup> - with comfort brightness regulation
Contrast	400 : 1
Resolution (in Pixel)	WVGA (1024*600)
MTBF backlight	50,000 h
Method of operation	Projected capacitive multi-touch screen; operation through high quality 2.8 mm glass
Protection class	IP20 according EN 60529
<b>General characteristics</b>	
Processor	Fanless ultra low consumption
Memory	2 GB RAM
Expansion slots	MicroSDHC Slot (ext) - free for customers' use - front-side accessible
Power Supply - Use one of the two	<ul style="list-style-type: none"> <li>■ PoE compatible with Cat5e/Cat6 UTP cable, max length 100 m IEEE Std 802.3at</li> <li>■ 12-32 VDC</li> </ul>
Power consumption	Max. 7 W
<b>Multimedia</b>	
Input/output	Microphone (ext) / Loudspeaker 2 Watt RMS (ext)
Functionality	Integrated Echo cancellation for bi-directional interphone communication
<b>Interfaces</b>	
LAN/Ethernet	1 x 10 / 100 Mbps with 802.3at PoE (ext)
USB	<ul style="list-style-type: none"> <li>■ 2 x USB 2.0 (2x external)</li> <li>■ 1 x mini USB OTG (front accessible)</li> </ul>
Battery	Battery free system - RTC with capacitor backup
<b>Surveillance</b>	
Status LEDs	1 x RGB LED
Security	Anti-theft retention
<b>Ambient Conditions</b>	
Temperature range (usage)	+0 °C to +30 °C max.
Authorisation	CE



# U.motion

## Data sheets

<b>Technical data</b>	
<b>U.motion Client Touch 7</b> <b>Art. no. MTN6260-0307</b> <b>Version 2</b>	
<b>Dimensions</b>	
Cut-Out with mounting box [mm]	129 x 210 x 75
Product Size [mm] (Length x Height x Width)	136 x 215 x 31
Weight	0.9 kg
<b>Mechanical Characteristics</b>	
Mounting	One man mounting system with: <ul style="list-style-type: none"><li>■ U.motion Touch 7 Mounting Set (Art. no. MTN6270-5001)</li></ul>
Orientation	For vertical and horizontal installation
Front	Full glass front with Aluminium Side Cover. The glass front has a black border.
<b>Accessories</b>	
Aluminium Side Cover	■ U.motion Touch 7 Design element (Art. no. MTN6270-4060)



## U.motion Client Touch 10/15

U.motion Client Touch 10 and U.motion Client Touch 15 visualise and control the current building conditions provided by a U.motion KNX Server/KNX Server Plus as well as the functions of the U.motion system.

These functions include:

- Control of lighting, blinds and room temperature-control of a KNX system
- Communication inside a building (intercom, communication to the door station)
- Monitoring of the building with IP cameras

U.motion Client Touch 10/Touch 15 use the Linux operating system. The colour touch panel will display the user interface after configuration.

Technical data	U.motion Client Touch 10 Art. no. MTN6260-0310	U.motion Client Touch 15 Art. no. MTN6260-0315
Type of design	An ultra compact embedded touch panel for wall mounting <ul style="list-style-type: none"> <li>■ noiseless and without any rotating parts</li> <li>■ homogeneous smooth glass surface with aluminium side border</li> </ul>	
<b>Software</b>		
Operating system	Linux	
<b>Front Unit</b>		
Size	25.6 cm (10.1") widescreen	39.6 cm (15.6") widescreen
Type	LED backlight TFT	LED backlight TFT
Luminosity	200 cd/m <sup>2</sup>	300 cd/m <sup>2</sup>
Contrast	400 : 1	500 : 1
Resolution (in Pixel)	WSVGA 1024x600	WXGA 1366x768
MTBF backlight	30,000 h	50,000 h
Method of operating	Projected capacitive touch screen with 3 mm glass front, dual touch capable	
Protection class	IP20 according EN 60529	
<b>General characteristics</b>		
Processor	Fanless ultra low consumption	
Memory	1 GB DDR2 SDRAM	
Power Supply	AC 100 – 240 V	
Power consumption	Max. 20 W	Max. 25 W
<b>Interfaces</b>		
LAN/Ethernet	1 x 10/100/1000 Mbps (ext)	
USB	4 x USB 2.0 (1x front accessible, 3x back accessible)	4 x USB 2.0 (2x front accessible, 2x back accessible)
Multimedia	Speaker and microphone included with echo cancellation	
<b>Ambient Conditions</b>		
Vibration/Shock resistance	15 G/50 G	
Temperature range (usage)	+0 °C to +30 °C max.	
Authorisation	CE	
<b>Dimensions</b>		
Product size [mm] (Length x Height x Width)	343 x 201 x 81	525 x 306 x 92
Product size with Design element [mm] (Length x Height x Width)	349 x 201 x 81	531 x 306 x 92
Weight	2.2 kg	6 kg

# U.motion

## Data sheets

Technical data	U.motion Client Touch 10 Art. no. MTN6260-0310	U.motion Client Touch 15 Art. no. MTN6260-0315
<b>Mechanical Characteristics</b>		
Mounting	One man mounting system with Schneider Electric mounting possibilities:	
	<ul style="list-style-type: none"> <li>■ U.motion Touch 10 Flush mounting box (Art. no. MTN6270-5004)</li> <li>■ U.motion Touch 10 Cavity wall set (Art. no. MTN6270-5005)</li> <li>■ U.motion Touch 10 Cavity wall set, flush mounting (Art. no. MTN6270-5006)</li> </ul>	<ul style="list-style-type: none"> <li>■ U.motion Touch 15 Flush mounting box (Art. no. MTN6270-5007)</li> <li>■ U.motion Touch 15 Cavity wall set (Art. no. MTN6270-5008)</li> <li>■ U.motion Touch 15 Cavity wall set, flush mounting (Art. no. MTN6270-5009)</li> </ul>
Orientation	For horizontal installation	
Front	Full glass front with Aluminium Side Cover. The glass front has a black border.	
<b>Accessories</b>		
Aluminium Side Cover	<ul style="list-style-type: none"> <li>■ U.motion Touch 10 Design element (Art. no. MTN6270-4160)</li> </ul>	<ul style="list-style-type: none"> <li>■ U.motion Touch 15 Design element (Art. no. MTN6270-4260)</li> </ul>

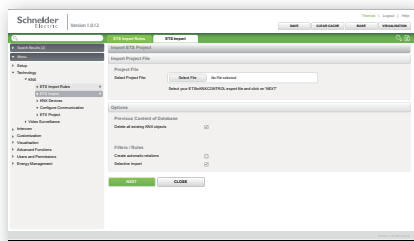

### Software specifications

System configuration is carried out in U.motion Builder, and you can either parameterise directly via the web interface of the server (internal access or remote access possible) or offline via the separate U.motion Builder software in a different location.

Below you will find the most important functions supported by U.motion.

Software specifications	U.motion KNX Server Art. no. MTN6501-0001	U.motion KNX Server Plus Art. no. MTN6501-0002
Standard technologies	KNX	KNX VoIP/SIP
User interface	Web/HTML5 (all operating systems) App support (iOS / Android)	
Client amount	Unlimited Note: The number of configured accesses is physically not limited. However, more than 20 simultaneously executed operations (devices in idle state not included) could slow down the response time of the system.	
Controllable elements	Illumination Heating/Cooling Blinds, shutters and contacts Thermo-control Energy management Load control Weather stations IP cameras -	Illumination Heating/Cooling Blinds, shutters and contacts Thermo-control Energy management Load control Weather stations IP cameras Intercom
Client: Browser compatibility	Google Chrome Apple Safari	
Client: Supported operating systems	Microsoft Windows, Apple Mac OSX, Linux, Apple iOS, Google Android	
Visualisation		
Layout	Different graphical themes Layout adapts to display resolution Automatic resize for mobile devices	
Performance	Commands are sent in real-time (performance may vary depending on the available network connection) Animation and graphical effects Support for HTML5 caching Optimized for iOS and Android	
Navigation	Customisable graphical pages Navigation through rooms on different levels Navigation through functionalities Complex functions with pop-up controls Navigation menu customisable and always visible Single-click access for most important functions	
Customisation	Favourites: adaptable by the end-customer Floorplan: individual background pictures can be implemented Floorplan: Rearrangement of icon positions and navigation links Room/Area: Individual pictures, LiveCam pictures Complex objects for individual cases Scenarios Time scheduling: adaptable by the end-customer	

# U.motion

## Data sheets

Software specifications	U.motion KNX Server Art. no. MTN6501-0001	U.motion KNX Server Plus Art. no. MTN6501-0002
Notifications	OnScreen notifications, Email	
Further services	Weather preview, RSS feeds, Web favourites, Message board	
<b>Setup and commissioning</b>		
Configuration possibilities	Online Offline through U.motion Builder (available for free)	
Configuration interface (IDE)	Search function Navigation menu with access to all functions Drag & drop Multi-Tab support for configuration of more than one object concurrently	
Setup and maintenance	Network Date/time Backup/restore of the project Language support (English/German/Spanish/Chinese) Selection of graphical themes and layout adaptations Software update via browser	
KNX visualisation	Group address import via esf. file Automatic creation of the functions Import rules connected to the KNX group addresses ETS gateway functionality also through internet	
Rooms/pages	Layout in grid and background view Background pictures freely customisable Free positioning of the functions	
Extended functionality	Scenarios including wait commands Complex objects for uniting functions Logic functions Value comparisons and conditions Virtual objects Integrators	
Timer/scheduling	Arbitrary amount of daily schedulings per object Weekly and yearly schedulings Configuration interface for final user	
Energy management	Support for KNX energy counter Support for KNX load controller Graphical display of consumption Visualisation of current load in real-time Periodic graphical representation (hours, days, months, years) Value comparison and direct load control Value comparison between different periods	
VoIP - Intercom	-	Up to 20 SIP members Call groups Automatic pop-up of incoming calls More than one video signal per external unit configurable Door opener Usable through SIP compatible smartphones
Users and security	Arbitrary amount of users Free distribution of user permissions Automatic login thanks to trusted IP configuration SSL protected remote access	

Accessories

U.motion Touch 7 Design Element | MTN6270-4060



- Design element for plugging onto:
  - U.motion Client Touch 7

	Width [mm]	Height [mm]	Depth [mm]
Touch 7	136	22	10

U.motion Touch 10/15 Design Element | MTN6270-4160, MTN6270-4260

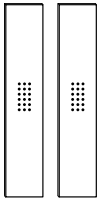

- Design element for plugging onto:
  - U.motion Client Touch 10/15
  - U.motion KNX Server Plus, Touch 10/15

	Width [mm]	Height [mm]	Depth [mm]
Touch 10	40	201	12
Touch 15	58	306	12

U.motion Touch 10/15 flush mounting box | MTN6270-5004, MTN6270-5007

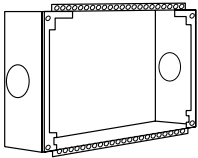

- Flush mounting box for:
  - U.motion Client Touch 10/15
  - U.motion KNX Server Plus, Touch 10/15

	Width [mm]	Height [mm]	Depth [mm]
Touch 10	325	202	80
Touch 15	508	308	80

U.motion Touch 10/15 cavity wall set | MTN6270-5005, MTN6270-5008, MTN6270-5006, MTN6270-5009

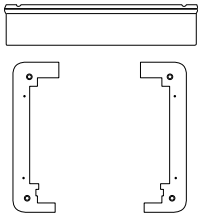

- Cavity wall set for:
  - U.motion Client Touch 10/15
  - U.motion KNX Server Plus, Touch 10/15

	Width [mm]	Height [mm]	Depth [mm]
Touch 10	354	211	47
Touch 15	537	318	59

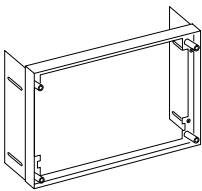

- Cavity wall set for flush mounting:
  - U.motion Client Touch 10/15
  - U.motion KNX Server Plus, Touch 10/15

	Width [mm]	Height [mm]	Depth [mm]
Touch 10	341	196	88
Touch 15	522	302	88

U.motion Touch 7 mounting set | MTN6270-5001

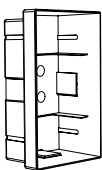

- Mounting set for flush-mounted or cavity wall installation
  - U.motion Client Touch 7

	Width [mm]	Height [mm]	Depth [mm]
Touch 7	130	211	80

# U.motion

## U.motion door communication

### U.motion door communication

#### Intercom and door communication

The intercom function enables audio and video communication via the IP network, either **between different terminal units or with door stations**.

In order to use intercom functions, a suitable U.motion server needs to be installed:

- U.motion KNX Server Plus
- U.motion KNX Server Plus, Touch

Intercom functions can be used on the following display devices:

- U.motion Client Touch 7
- U.motion Client Touch 10
- U.motion Client Touch 15
- U.motion KNX Server Plus, Touch
- PC/Mac with suitable browser with JAVA support for VoIP
- Smartphones and tablet PCs with an Android operating system

When the U.motion user interface is used, bidirectional audio communication is possible. VoIP communication requires the software and hardware of third-party devices to comply with the SIP standard. The **U.motion Communication App** is available for devices with an Android operating system (Google Play™ Store).

For U.motion Client Touch 10/15, KNX Server Plus Touch and PC/MAC there is also the option of communicating with **users**. All these aforementioned devices that the user is currently logged into are called via the name or phone number of the user.

#### Door communication with U.motion KNX Server Plus

Individual U.motion devices or call groups can be contacted from a door station depending on the number of bell push-buttons. A call group can be formed of users as well as devices.

Limits for each U.motion KNX Server Plus:

- Maximum of 3 call groups
- Maximum of 3 door stations
- Maximum of 10 internal participants. Further connections can be set up with U.motion Client Touch 10/15 and PCs/MACs in addition to the 10 internal participants.

#### U.motion door station set

U.motion door station set, 1 unit  
U.motion door station set, 2 units

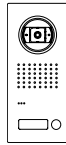

MTN6910-0033

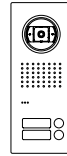

MTN6910-0034

You can use the U.motion door station set to establish a connection between the enclosed door station and the intercom devices from U.motion.

#### Function

Each set includes a door station with either one or two bells. Individual devices, users or call groups can be called via a bell push-button.

You can therefore also use the U.motion door station set, 2 units (MTN6910-0034), for two separate accommodation units.

Images from the video camera at the door station are displayed on the called devices. The call can then be received and the door can be opened. If it is installed, the staircase lighting can also be activated.

#### Wiring

The door station uses PoE and must be connected to a PoE-compatible network.

The video encoder converts analogue video signals from the door station into network-compatible signals for the U.motion KNX Server Plus/KNX Server Plus Touch. The device may only be connected to a PoE-compatible network.

The IP switching device has two potential-free switch outputs, which you can use to control an electric door opener and switch on the staircase lighting. The device requires an AC 230 V supply voltage.

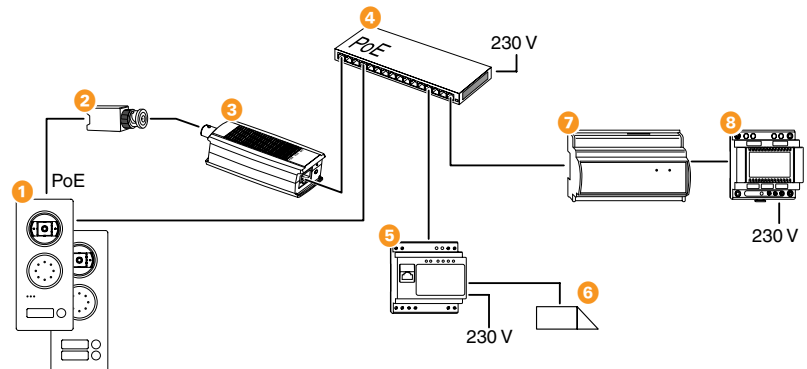

#### Key

- |   |                                     |                             |
|---|-------------------------------------|-----------------------------|
| 1 | Stainless steel door station video  | MTN6910-0033 / MTN6910-0034 |
| 2 | Passive video transceiver           | MTN6910-0033 / MTN6910-0034 |
| 3 | Video encoder                       | MTN6910-0033 / MTN6910-0034 |
| 4 | PoE switch                          |                             |
| 5 | IP switching device                 | MTN6910-0033 / MTN6910-0034 |
| 6 | Door opener for IP switching device |                             |
| 7 | U.motion KNX Server Plus            | MTN6501-0002                |
| 8 | Power supply                        | MTN693004 / MTN693003       |

#### Software for door communication

The following software is needed for configuration:

- **AXIS IP Utility:** Software for configuration of the video encoder. Axis is a registered trade mark of AXIS AB in various legal systems.
- **U.motion Builder:** Included with the U.motion KNX Server Plus
- **IP start-up software:** Free software for configuring door stations and IP switching devices

## Technical data

### Door station

Power supply:	PoE class 0
Elements:	Built-in loudspeaker, colour camera, 1 bell push-button (MTN6910-0033), 2 bell push-button (MTN6910-0034)
Colour camera:	Mechanically adjustable
□ Total surveillance range:	150° horizontal/90° vertical
Bell push-buttons:	Back-lit with white LEDs
Nameplates:	Illuminated; can be changed from the front with no additional tools
Faceplate dimensions:	
□ MTN6910-0033:	355 x 154 x 2.5 mm (HxWxD)
□ MTN6910-0034:	355 x 154 x 2.5 mm (HxWxD)
Flush-mounted box dimensions:	
□ MTN6910-0033:	331 x 130 x 52 mm (HxWxD)
□ MTN6910-0034:	361 x 130 x 52 mm (HxWxD)

### IP Switching device

Power supply:	AC 230 V
Output voltage for door opener:	AC 9 V/600 mA
Switch contacts:	2
□ Switching current:	10 A ohmic load, 6 A inductive/capacitive load
Input:	1, for potential-free contacts for controlling the IP switching device
Dimensions:	90 x 90 x 50 mm (HxWxD)
Device width:	5 modules

### Video encoder

Power supply:	PoE class 2
Displays:	3 LEDs for power, status and network
Connections:	RJ45 (PoE class 2), BNC
Operating elements:	75 ohm termination, control button (reset)
Max. cable length	250 m coaxial video cable
Dimensions:	30 x 37 x 101 mm (HxWxD)
Weight:	82 g



