



AZL21...



AZL23...

Display and Operating Units

AZL2...

The AZL2... display and operating units are designed for use with LMV2... / LMV3... and LME39... burner controls, either directly on the burner or in control panels installed close to the burner.

- The units are used for the display, operation and parameterization of specific safety- and non-safety-related burner functions
- Key plant data and fault codes can be queried and displayed
- Communication between AZL2... and burner control takes place via BCI interface

The AZL2... and this Data Sheet are intended for use by OEMs which integrate the display and operating units in their products!

Listed below is the full scope of functions of the AZL2...units.

The specific functions and operating philosophy depend on the type of burner control with which the display and operating unit is used.

- Housing of modern design made of recyclable plastic
- Flame-resistant housing material

AZL21...

- Display of operating states, program phases and fault codes
- Setting of parameters and ratio curves
- 8-digit LCD with bars
- LCD with backlit (support dependent on respective burner control)
- 5 multifunction buttons with reset facility
- Housing designed for wall mounting
- Degree of protection IP40 when mounted
- BCI interface
- Prepared for extra fault indication via LED (on request)
- Backup / restore function with specific types of burner controls (on request)

AZL23...

- Display of operating states, program phases and fault codes
- Setting of parameters and ratio curves
- 8-digit LCD with bars
- LCD with backlit (support dependent on respective burner control)
- 5 multifunction buttons with reset facility
- Housing designed for flush-panel mounting
- Degree of protection IP54 when mounted
- BCI interface
- Backup / restore function with specific types of burner controls (on request)

Warning notes



For additional safety notes, refer to the technical documentation of the relevant burner controls!

To avoid injury to persons, damage to property or the environment, the following warning notes must be observed!

Notes on product liability

- The units may only be used in building services plant and only in compliance with the applications described in this Data Sheet
- When employing the products, all requirements specified in the following sections must be observed
- Local safety regulations (installation, etc.) must be complied with
- The units must not be opened. If violated, warranty by Siemens becomes void



Caution

Do not open, interfere with or modify the units!

- All activities (mounting, installation and service work, shut down etc.) must be performed by qualified staff
- Before making any wiring changes in the connection area, completely isolate the plant from mains supply (all-polar disconnection). Ensure that the plant cannot be inadvertently switched on again and that it is indeed dead. If not observed, there is a risk of electric shock hazard
- Ensure protection against electric shock hazard by providing adequate protection for the connection terminals
- Each time work has been carried out (mounting, installation, service work, shut down, etc.), check to ensure that wiring and catch mechanism of the BCI interface (jack RJ11) into the AZL2... housing and parameterization is in an orderly state
- Fall or shock can adversely affect the safety functions. Such units must not be put into operation, even if they do not exhibit any damage

Siemens will not assume liability for damage resulting from unauthorized interference!

Electromagnetic emissions must be checked on an application-specific basis!

Qualified staff

Only **qualified staff** are allowed to install and operate the units. Qualified staff in the context of the safety-related notes contained in this Data Sheet are persons who are authorized to commission, ground and tag devices, systems and electrical circuits in compliance with established safety practices and standards.

Correct use

Note the following:

The units may only be used on the applications described in the technical documentation and only in connection with burner controls supplied by Siemens.

The products can only function correctly and safely if shipped, stored, set up and installed correctly, and operated and maintained as specified.

Mounting notes

- Ensure that the relevant national safety regulations are complied with
- Observe that the screw-on area must be flat.
- Always use the AZL2... in dry and clean environments

Flush-panel mounting AZL23...

Step 1

Place the AZL2... into the cutout as shown (without applying any force).

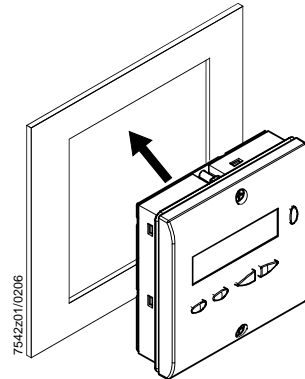

Step 2

Secure the AZL2... with the 2 Phillips-head screws provided (without applying any force).

Note:

If the AZL2... does not fit in the cutout, check the dimensions of cutout and housing.

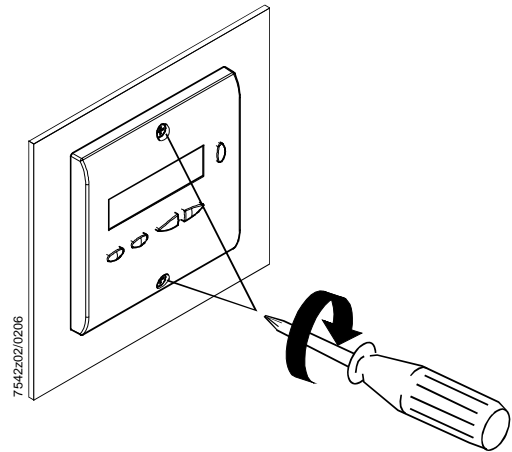

- Observe a tightening torque of 0.4 Nm for the screws to ensure the requirements of IP54 are satisfied

Dimensions of cutout AZL23...

The units' mounting dimensions are 92 x 92 mm. Due to the front's dimensions, the resulting spacing is 96 mm. Thanks to the mounting mechanism, the units can be fitted in panel fronts of different material thicknesses (1...3 mm).

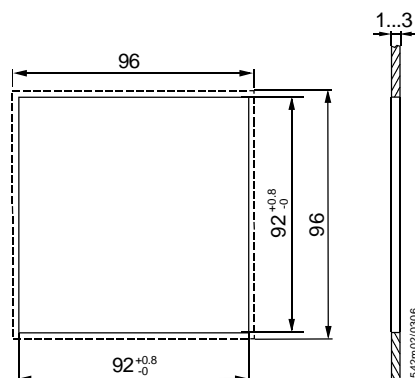









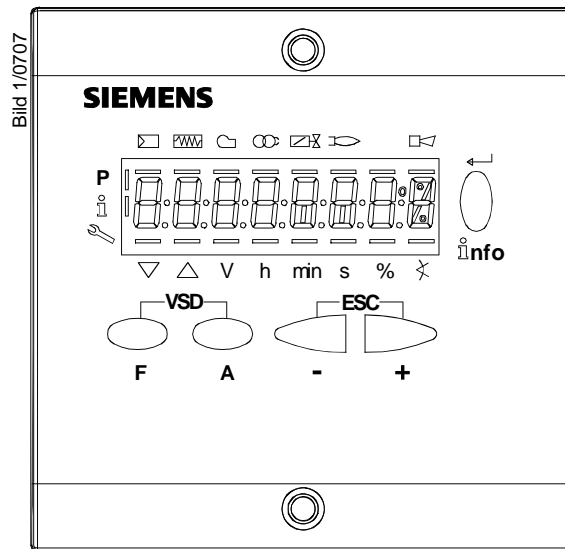









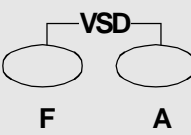



AZL21...

- Ensure that the mounting surface is completely flat
- Use screws M5 with washers (e.g. similar to 10-UNF)

Operating / display philosophy

For operating and display philosophy, refer to the User Manuals of the respective types of burner controls. Function and operation of the different types of AZL2... are identical.

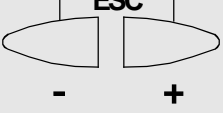

Button	Function
 F	F button - For driving the fuel actuator to another position (keep  depressed and adjust the value by pressing  or )
 A	A button - For driving the air actuator to another position (keep  depressed and adjust the value pressing  or )
 F A	F and A buttons - For changing to parameter setting mode P (press simultaneously  and  plus  or ) - For readjusting the speed of the VSD operation (press  and  with  or  simultaneously)
 info	Info and Enter button - For navigating in info and service mode * Incrementing the selection (flashing symbol) (press button for <1 s) * Going one menu level down (press button for 1...3 s) * Going one menu level up (press button for 3...8 s) * Changing to operating mode (press button for >8 s) - Enter in parameter setting mode - Reset in the event of fault - One menu level down
 -	- button - For decreasing the value - For navigating during curve adjustments in info and service mode
 +	+ button - For increasing the value - For navigating during curve adjustments in info and service mode
 - +	- and + buttons: Escape function (press  and  simultaneously) - No adoption of value - One menu level up

Meaning of symbols on the display

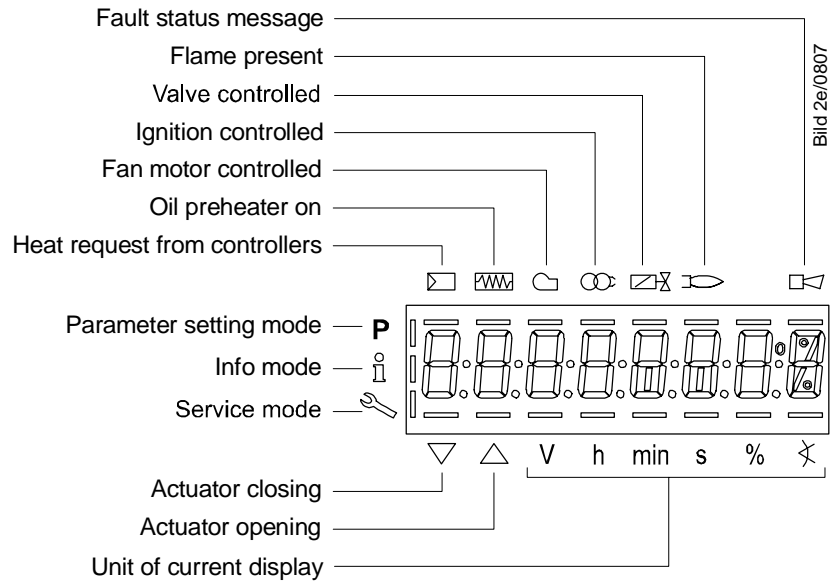

Installation notes

- The plugs of the connecting cables for the AZL2... may only be removed or replaced when the plant is disconnected from power (all-polar disconnection) since there is no safe separation between BCI interface and mains voltage
- Signal cable AGV50... from the burner control to AZL2...
Since there is no safe separation between BCI interface and mains voltage, the signal cable AGV50... from the burner control to the AZL2... must conform to the specification given (refer to «Technical data»). The specification of the signal cable AGV50... required for this application is given inside the burner cover. When using signal cables that do not comply with the specification, there is a risk that requirements will not be satisfied
- Do not lay the signal cable AGV50... from the burner control to the AZL2... together with other cables
- The signal cable AGV50... and the AZL2... must be shipped and stored such that dust and water cannot have any adverse effect
- To ensure protection against electric shock hazard, make certain that – prior to switching on mains voltage – the cable is correctly connected to the AZL2...
- The AZL2... must be used in a dry and clean environment
- Prior to installation, the units must be disconnected from power
- Wiring must satisfy the requirements of safety class II
- Static charges must be avoided since they can damage the electronic components of the units when touched

Recommendation: Use ESD equipment!



Danger

- DIN EN 60 335 and DIN EN 60 730-2-5 must be complied with
 - The electrical wiring inside the boiler must conform to national and local regulations
 - Degree of protection IP40 / IP54 as per DIN EN 60 529 for burner controls must be ensured by the burner or boiler manufacturer through correct installation of the AZL2...
-

Commissioning notes

Prerequisites

- The burner or boiler manufacturer assumes responsibility for the correct parameterization of the burner controls in compliance with the relevant standards and directives

Standards and certificates

Only in connection with burner controls



Conformity to EEC directives
- Electromagnetic compatibility EMC (immunity)
- Low-voltage directive

2004/108/EC
2006/95/EC



ISO 9001: 2000
Cert. 00739



ISO 14001: 2004
Cert. 38233



Disposal notes



The units contain electrical and electronic components and must not be disposed of together with domestic waste. Local and currently valid legislation must be observed.

Type summary

AZL21.00A9

Display and operating unit for wall mounting
- Basic Documentation P7541 for LMV2...
- Basic Documentation P7546 for LMV3...
- Basic Documentation P7106 for LME39...



AZL23.00A9

Display and operating unit for flush-panel mounting
- Basic Documentation P7541 for LMV2...
- Basic Documentation P7546 for LMV3...
- Basic Documentation P7106 for LME39...



Supplementary documentation

Gas burner control LME39...

refer to Data Sheet N7106
Basic Documentation P7106

Burner management system LMV2...

refer to Data Sheet N7541 or
Basic Documentation P7541

Burner management system LMV3...

refer to Data Sheet N7546 or
Basic Documentation P7546

Technical data

General unit data	Operating voltage	DC 5 V
	Power consumption	<50 mW (typically)
	Degree of protection	
	- AZL21...	IP40 to IEC529
	- AZL23...	
	- Rear	IP40 to IEC529
	- Front	IP54 to IEC529 when mounted
	Safety class	II to DIN EN 60730-1
	Housing	
	- Material	PC and PC / ABS
	- Color	RAL 7035 (light-grey)
	Flame protection class	
	- Transparent housing parts	To UL94 V2 (PC)
	- Colored housing parts	To UL94 V0 (PC / ABS)
Weight		
- AZL21...	Approx. 85 g	
- AZL23...	Approx. 120 g	
Degree of contamination	2	
Signal cable AGV50... display → BCI	Signal cable	Color white Unshielded Conductor 4 x 0.141 mm ² With connector RJ11
	Cable length	
	- AGV50.100	1 m
	- AGV50.330	3 m
	Supplier	Reference: Hütter http://www.huetter.co.at/telefonkabel.htm Order number: T11721004
Location	Under the burner hood (arrangements for SKII EN60730-1 additional required)	
For permissible length of cable, refer to the Data Sheet of the relevant type of burner control.		
Inputs / outputs	BCI interface with RJ11 female	For Siemens burner controls
Environmental conditions	Storage	DIN EN 60721-3-1
	Climatic conditions	Class 1K3
	Mechanical conditions	Class 1M2
	Temperature range	-20...+60 °C
	Humidity	<95 % r.h.
	Transport	DIN EN 60721-3-2
	Climatic conditions	Class 2K3
	Mechanical conditions	Class 2M2
	Temperature range	-30...+60 °C
	Humidity	<95 % r.h.
	Operation	DIN EN 60721-3-3
	Climatic conditions	Class 3K3
	Mechanical conditions	Class 3M3
	Temperature range	-20...+60 °C
Humidity	<95 % r.h.	



Condensation, formation of ice and ingress of water are not permitted!

Connection diagram

Example: Basic diagram AZL2... with LMV27.1...

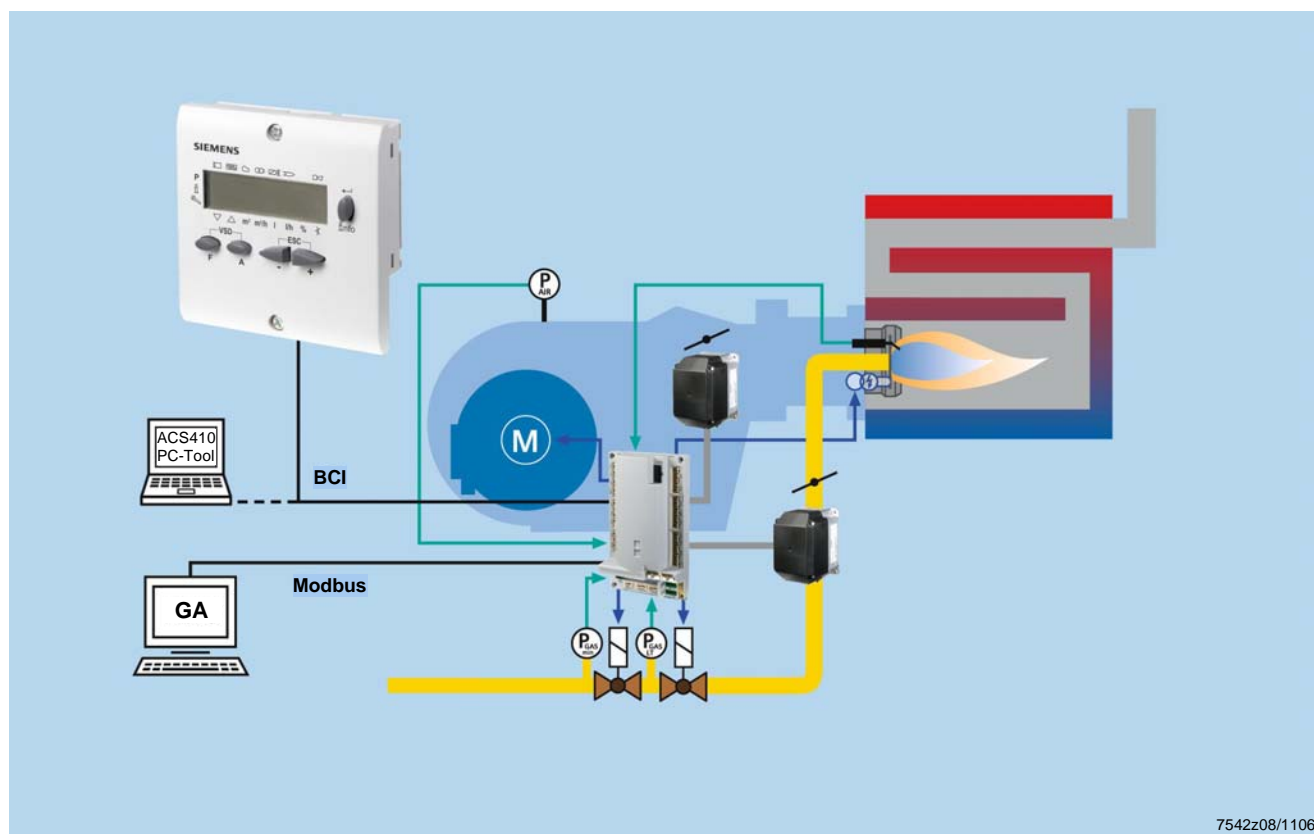

Connection of AZL21...
to LME39...

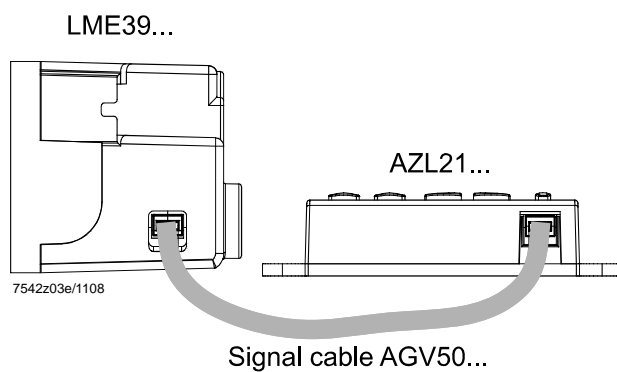

Connection of AZL23...
to LMV2... / LMV3...

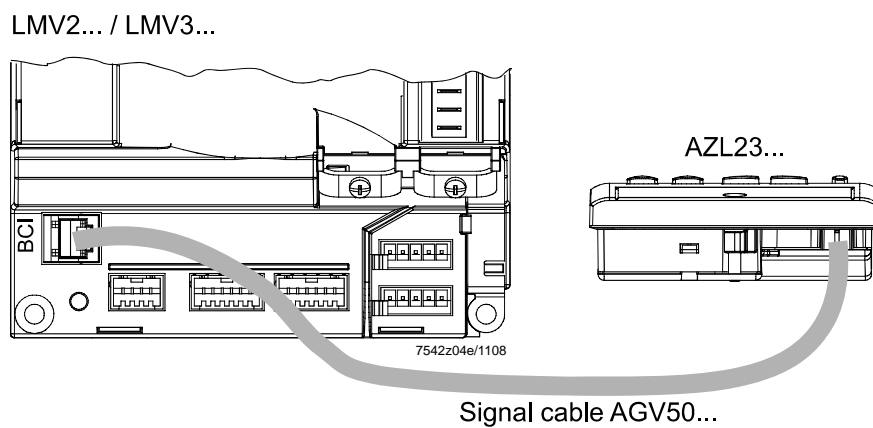

Dimensions

Dimensions in mm

AZL21...

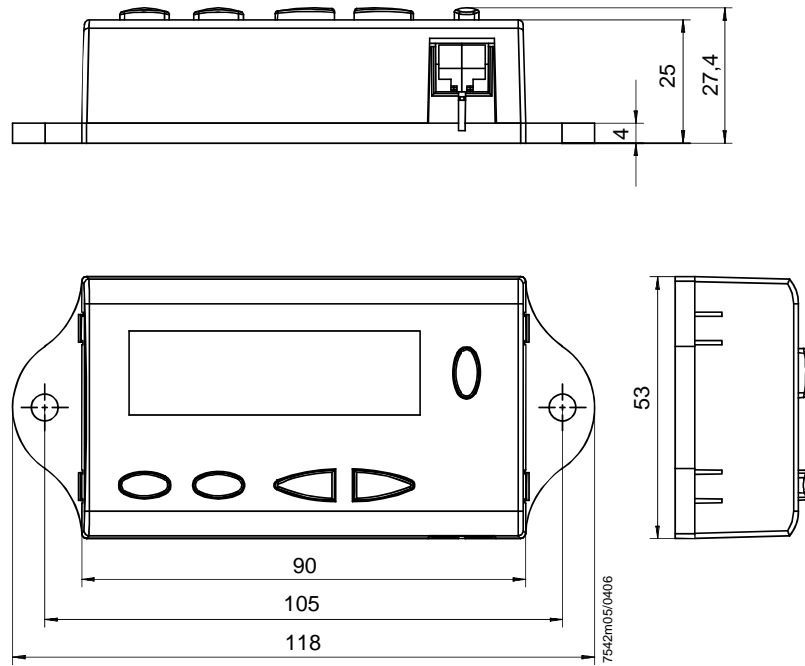

AZL23...

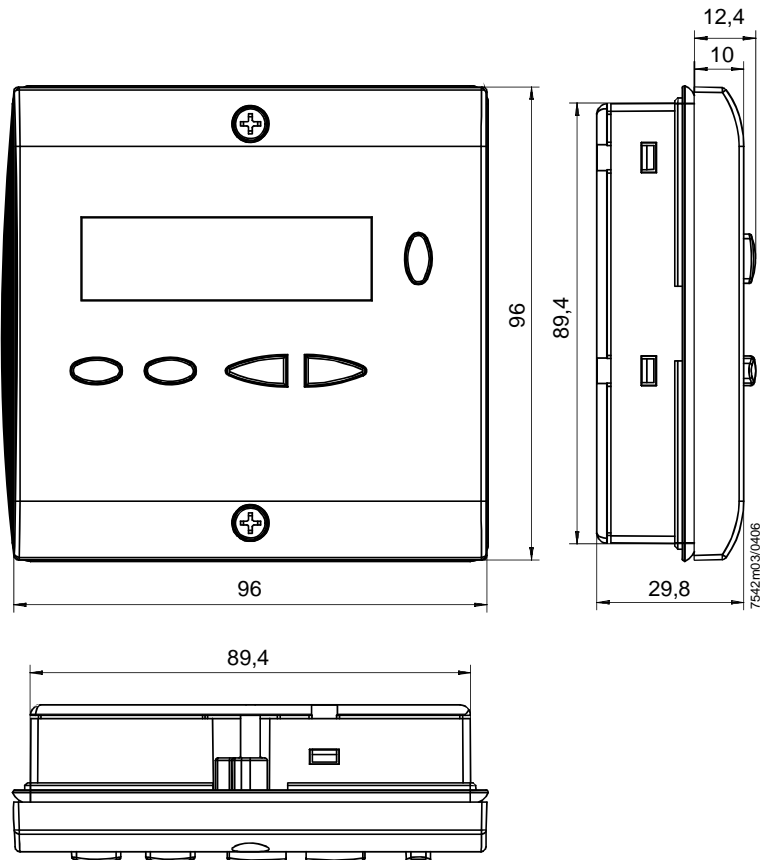

© 2008 Siemens Building Technologies HVAC Products GmbH
Subject to alteration!