



RDF301, RDF600KN



RDF301.50



RDF301.50H

Semi flush-mount communicating room thermostats

RDF301
RDF301.50..
RDF600KN

For 2-pipe, 2-pipe with electric heater, and 4-pipe fan coil units
For use with compressors in DX type equipment

- KNX bus communications (S-mode and LTE mode)
- Backlit display
- 2P / PI / P control
- Outputs for on/off or 3-position control
- Outputs for 3-speed or 1-speed fan
- 2 multifunctional inputs for keycard contact, external sensor, etc.
- Operating modes: Comfort, Economy and Protection
- Automatic or manual fan speed control
- Automatic or manual heating/cooling changeover
- Minimum and maximum limitation of room temperature setpoint
- Control depending on the room or the return air temperature
- Adjustable commissioning and control parameters
- Commissioning with Synco ACS, ETS or via local HMI
- Integration into Synco
- Integration into Desigo and Apogee via group addressing (ETS) or via individual addressing
- Integration into third-party system via group addressing (ETS)
- AC 230 V operating voltage
- User and parameter settings can be retained or restored with power loss

Additional RDF600KN features:

- Independent function for window contact and presence detector

Additional RDF301.50 features:

- Four buttons to control KNX actuators via KNX S-mode (functions: switching, dimming, blinds control, 8-bit scene)

Additional RDF301.50H features:

- Four buttons for hotel functions MUR (Make Up Room), DND (Do Not Disturb) via KNX S-mode

Type of mounting / suitable conduit boxes:

- RDF600KN for round box, with min 60 mm diameter, min 40 mm depth and recessed square box with 60.3 mm fixed centers
- RDF301... for recessed square box with 60.3 mm fixed centers

Use

Room temperature control (heating or cooling) in individual rooms and zones by means of:

- 2-pipe fan coil units
- 2-pipe fan coil units with electric heater
- 4-pipe fan coil units
- Compressors in DX-type equipment
- Compressors in DX-type equipment with electric heater

The RDF301... / RDF600KN controls:

- One 1-speed or 3-speed fan
- One or two on/off valve actuators
- One on/off valve actuator and one 1-stage electric heater
- One 3-position valve actuator
- One 1-stage compressor in DX-type equipment, or one 1-stage compressor with electric heater

Used in systems with:

- Heating or cooling mode
- Automatic heating/cooling changeover
- Manual heating/cooling changeover
- Heating and cooling mode (e.g. 4-pipe system)

The room thermostats are delivered with a fixed set of applications.

The relevant application is selected and activated during commissioning using one of the following tools:

- Synco ACS
- ETS
- Local DIP switch and HMI

Functions

- Room temperature control via built-in temperature sensor or external room temperature / return air temperature sensor.
- Changeover between heating and cooling mode (automatically via local sensor or bus, or manually).
- Selection of applications via DIP switches or commissioning tool.
- Selection of operating mode via operating mode button on the thermostat.

- Temporary Comfort mode extension.
 - 1-speed or 3-speed fan control (automatically or manually).
 - Display of current room temperature or setpoint in °C and/or °F.
 - Minimum and maximum limitation of room temperature setpoint.
 - Button lock (automatically and manually).
 - 2 multifunctional inputs, freely selectable for:
 - Sensor for automatic heating/cooling changeover
 - External room temperature or return air temperature sensor
 - Dew point sensor
 - Electric heater enable
 - Fault input
 - Monitor input for temperature sensor or switch state
- RDF301...:
- Operating mode switchover contact ... (keycard, window contact, etc)
- RDF600KN:
- Window contact
 - Presence detector
- Advanced fan control function, e.g. fan kick, fan start, selectable fan operation (enable, disable or depending on heating or cooling mode).
 - Purge function together with 2-port valve in a 2-pipe changeover system.
 - Reminder to clean fan filters (adjust with P62).
 - Floor heating temperature limitation.
 - Reload factory settings for commissioning and control parameters.
 - KNX bus (terminals CE+ and CE-) for communication with Synco or KNX compatible devices.
 - Display of outdoor temperature or time of day via KNX bus.
 - Time scheduling and central control of setpoints via KNX bus.
 - With a Synco RMx7xx controller, the energy demand signal of the thermostat is used to optimize energy supply.

RDF301.50 only:

- Four buttons to control KNX actuators via KNX S-mode. ("Switching groups" with functions such as switching, dimming, blinds control, 8-bit scene).

RDF301.50H only:

- Four buttons for Hotel applications to control via KNX S-mode. Same functions as RDF301.50, but with dedicated button labels for hotel applications: Make Up Room (MUR), Do Not Disturb (DND).

Applications

The thermostats support the following applications, which can be configured using the DIP-switches on the inner side of the thermostat's front panel or a commissioning tool.

Remote configuration

All DIP switches need to be set to OFF (remote configuration, factory setting) to select an application via commissioning tool.

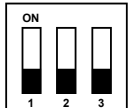
| | |
|---|--|
| <p>Remote configuration, via commissioning tool (factory set)</p> <ul style="list-style-type: none"> • Synco ACS • ETS | <p>DIP switches</p>  |
|---|--|

Applications for fan coil systems

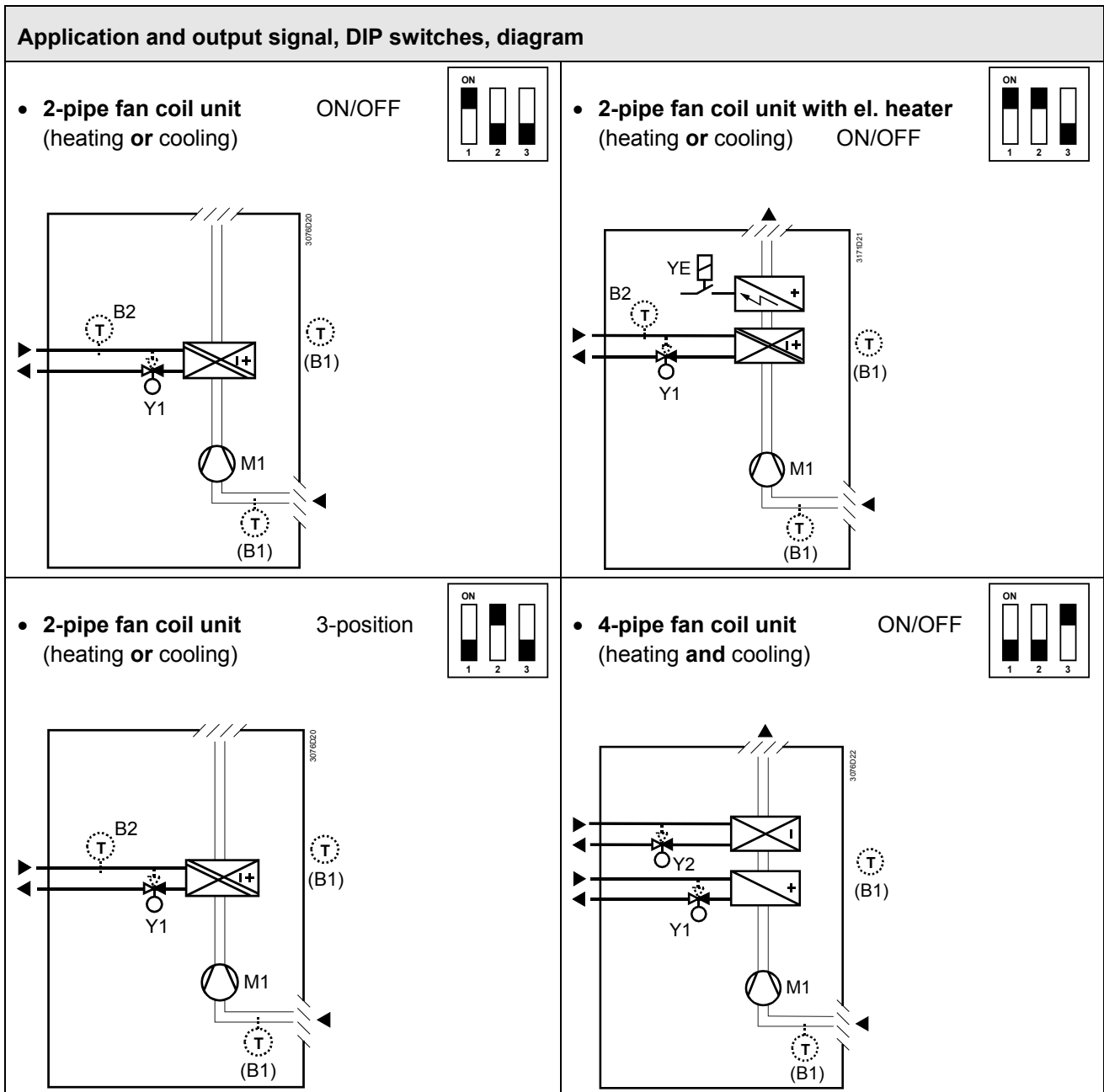

Legend

Y1 Heating or heating/cooling valve actuator
 Y2 Cooling valve actuator
 YE Electric heater
 N1 Thermostat

B1 Return air temperature sensor or external room temperature sensor (optional)
 B2 Changeover sensor (optional)
 M1 1-speed or 3-speed fan

Applications for Universal systems

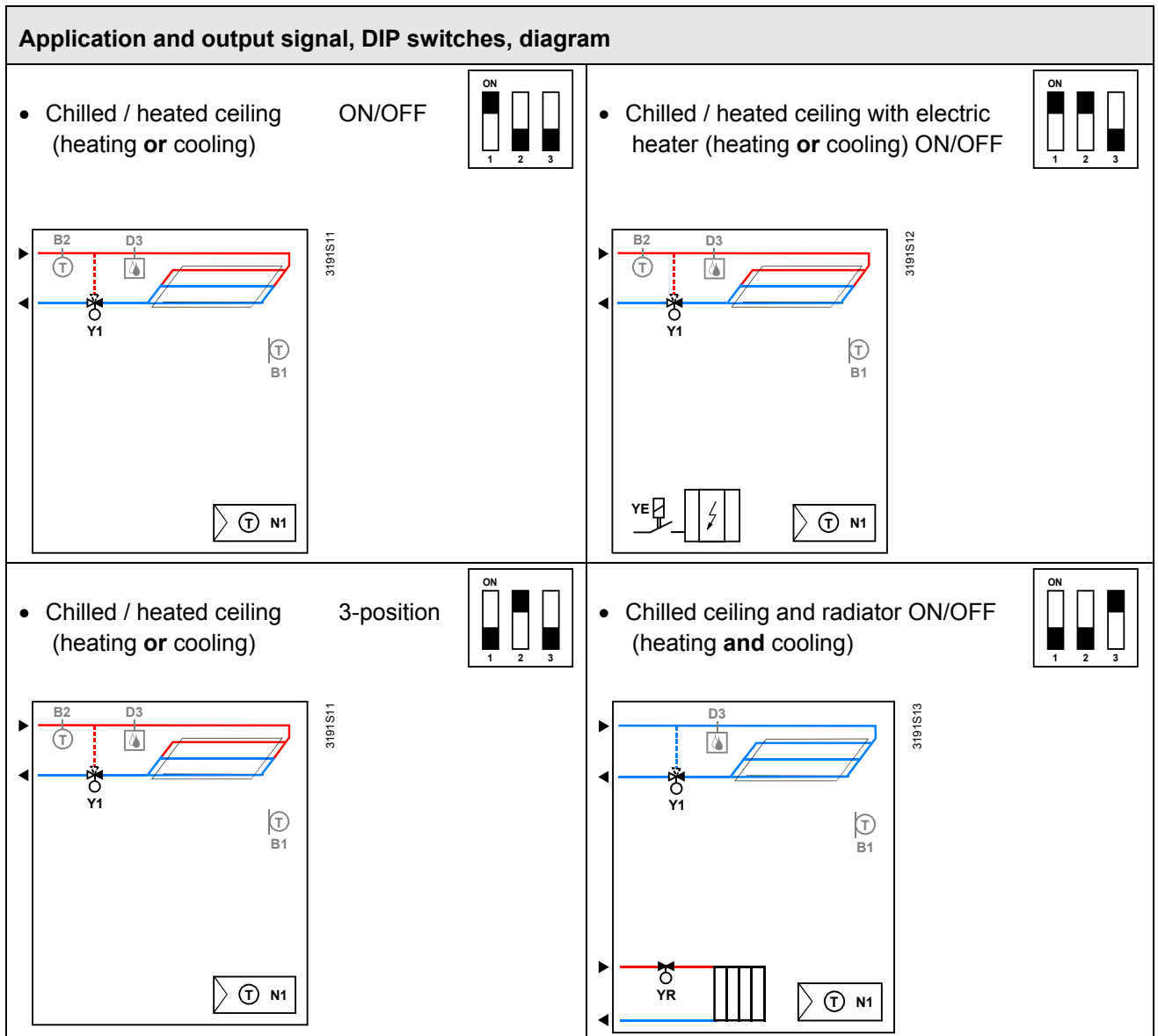

- | | | |
|--------|---|---|
| Legend | <ul style="list-style-type: none"> Y1 Heating or heating/cooling valve actuator YR Radiator valve actuator YE Electric heater N1 Thermostat | <ul style="list-style-type: none"> B1 Return air temperature sensor or external room temperature sensor (optional) B2 Changeover sensor (optional) M1 1-speed or 3-speed fan D3 Dewpoint sensor |
|--------|---|---|

Applications for heat pump systems

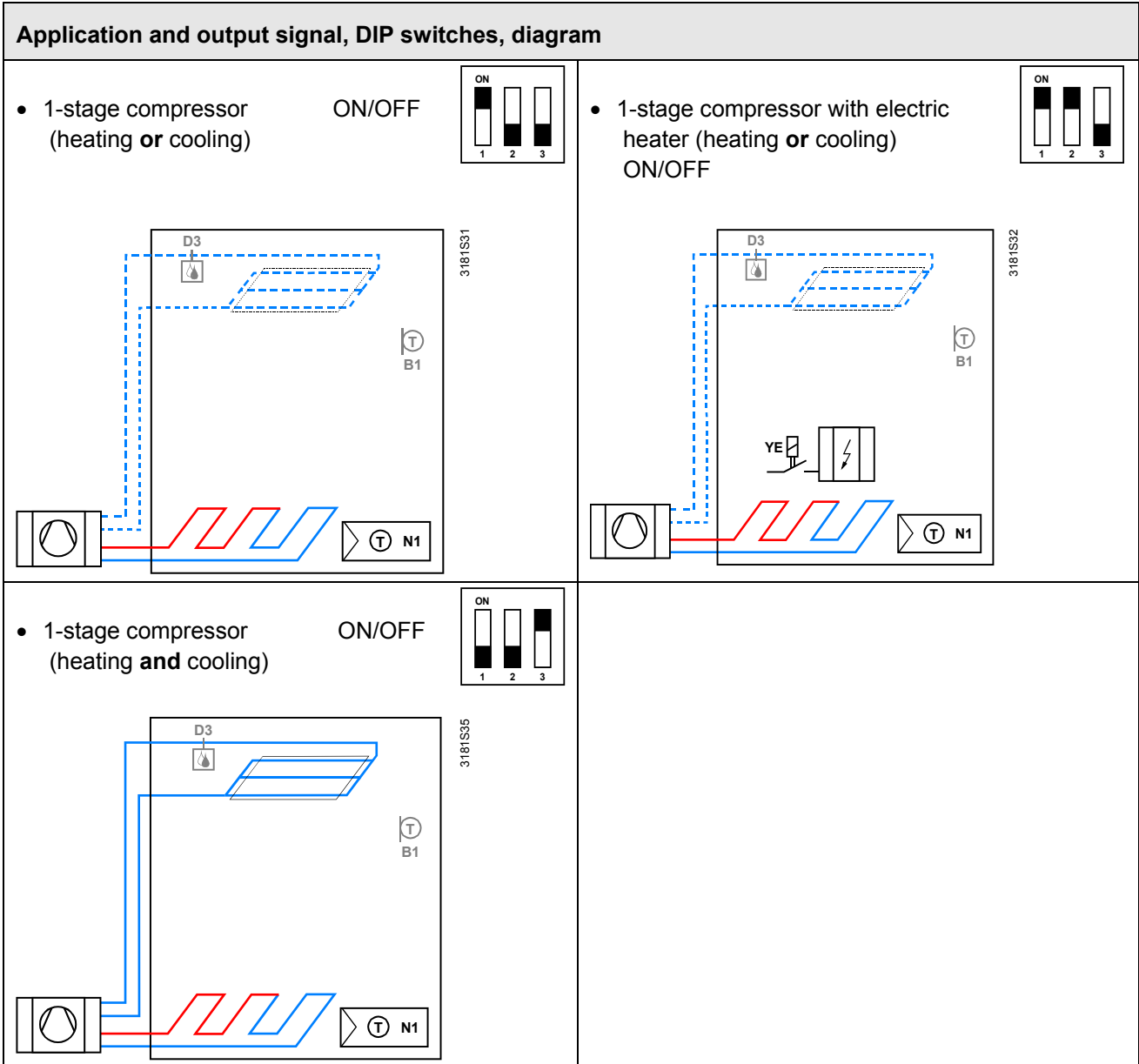

| | | |
|--------|--------------------|---|
| Legend | N1 Thermostat | B1 Return air temperature sensor or external room temperature sensor (optional) |
| | YE Electric heater | D3 Dewpoint sensor |

Type summary

| Product no. | Stock no. | Operating voltage | Control outputs | | | | Suitable conduit box ²⁾ |
|-------------|-------------|-------------------|-----------------|-----------------|------------|-------------------------------|------------------------------------|
| | | | 3-pos | ON/OFF | DC 0..10 V | KNX switching groups | |
| RDF301 | S55770-T104 | AC 230 V | 1 ¹⁾ | 2 ¹⁾ | -- | | square |
| RDF301.50 | S55770-T105 | AC 230 V | 1 ¹⁾ | 2 ¹⁾ | -- | ✓ | square |
| RDF301.50H | S55770-T334 | AC 230 V | 1 ¹⁾ | 2 ¹⁾ | -- | Hotel: MUR, DND ³⁾ | square |
| RDF600KN | S55770-T293 | AC 230 V | 1 ¹⁾ | 2 ¹⁾ | -- | | round or square |

¹⁾ Selectable: on/off or 3-position.

²⁾ Square conduit box e.g. ARG71.

Round CEE conduit box min 60 mm diameters and min 40 mm depth.









³⁾ MUR: Make Up Room, DND: Do Not Disturb.

Ordering







- When ordering, indicate both product number / SSN number and name:
E.g. **RDF301 / S55770-T104 room thermostat**
- Order valve actuators separately.

Equipment combinations

On/off actuators

| Type of unit | | Product no. | Data sheet |
|--|---|--|------------|
| Cable temperature sensor or changeover sensor |  | QAH11.1 | 1840 |
| Room temperature sensor |  | QAA32 | 1747 |
| Condensation monitor |  | QXA2601 QXA2602 QXA2603 QAX2604 | 3302 |
| Electromotoric ON/OFF actuator |  | SFA21... | 4863 |
| Electromotoric ON/OFF valve and actuator (only available in AP, UAE, SA and IN) |  | MVI.../MXI... | 4867 |
| Zone valve actuators (only available in AP, UAE, SA and IN) |  | SUA... | 4832 |
| Thermal actuator (for radiator valves), NO |  | STA23... | 4884 |
| Thermal actuator (for small valves 2.5 mm), NC |  | STP23... | 4884 |

3-position actuators



| | | | |
|---|---|-----------------|------|
| Electrical actuator, 3-position (for radiator valve) |  | SSA31... | 4893 |
| Electrical actuator, 3-position (for 2- and 3-port valves / V...P45) |  | SSC31 | 4895 |
| Electrical actuator, 3-position (for small valve 2,5 mm) |  | SSP31... | 4864 |
| Electrical actuator, 3-position (for small valve 5,5 mm) |  | SSB31... | 4891 |
| Electrical actuator, 3-position (for small valve 5,5 mm) |  | SSD31... | 4861 |
| Electromotoric actuator, 3-position (for valves 5.5 mm) |  | SQS35... | 4573 |

Note:

For the maximal number of actuators in parallel, refer to information in the data sheets of the selected actuators and to this list, depending on which value is lower:

- Parallel operation of max 6 SS... actuators (3-pos) is possible.
- Parallel operation of max 10 on/off actuators is possible.
- Parallel operation of SQS35 is not possible.

Accessories

| Designation | | Product no / SSN | Data sheet |
|--|--|----------------------------|------------|
| Changeover mounting kit (50 pcs/package) |  | ARG86.3 | N3009 |
| Plastic mounting bracket for semi-flush-mount thermostats for increasing the headroom in the conduit box by 10mm |  | ARG70.3 | N3009 |
| Conduit box for semi-flush mounted thermostat RDF301... |  | ARG71 / S55770-T137 | N3009 |
| KNX Power supply 160 mA (Siemens BT LV) | | 5WG1 125-1AB02 | -- |
| KNX Power supply 320 mA (Siemens BT LV) | | 5WG1 125-1AB12 | -- |
| KNX Power supply 640 mA (Siemens BT LV) | | 5WG1 125-1AB22 | -- |

Mechanical design

The thermostats consist of 2 parts:

- Front panel with electronics, operating elements and built-in room temperature sensor.
- Mounting base with power electronics.

The rear of the mounting base contains the screw terminals.

Slide the front panel in the mounting base and snap on.

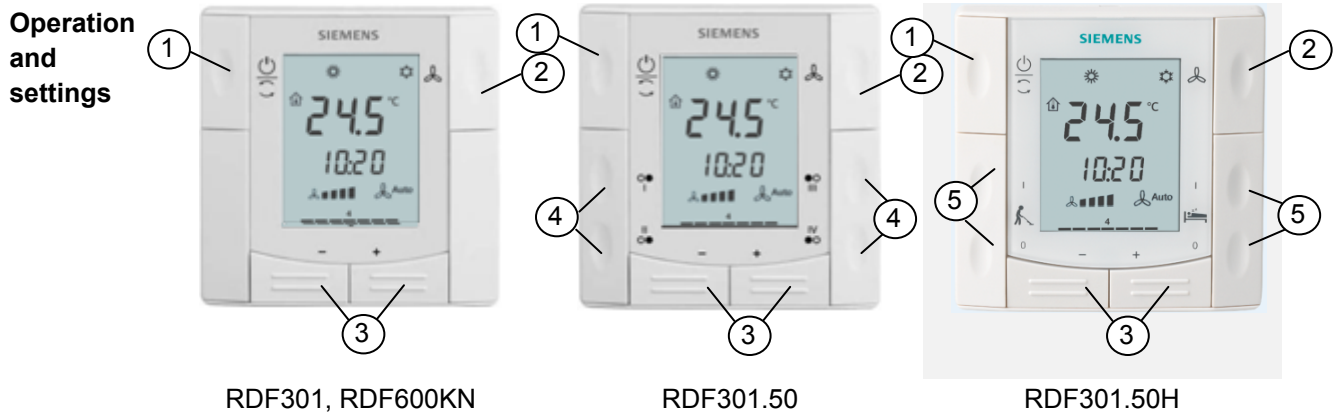

RDF301, RDF600KN

RDF301.50

RDF301.50H

1 Operating mode selector

2 Change fan operation

3 Adjust setpoint and control parameters

RDF301.50

4 Four buttons to control KNX actuators via KNX S-mode

(functions: switching, dimming, blinds control, 8-bit scene)

RDF301.50H

5 Four dedicated buttons for hotel functions (Make Up Room, Do Not Disturb) via KNX S-mode (functions: switching)

Display

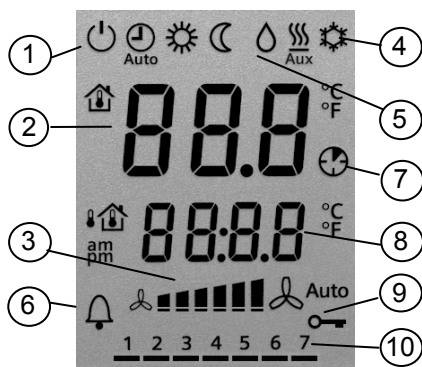

1 Operating mode

☐ Protection

☀ Comfort

☾ Economy

🕒 Auto Timer according to schedule (via KNX)

2 Displays room temperature, set-points and control parameters.

🏠 Symbol indicates current room temperature

3 Fan mode

🌀 Auto Auto fan active

🌀 Fan speed low, medium, high

4 Heating/cooling mode

❄ Cooling

🔥 Heating

🔥 Aux Electric heater active

5 💧 Condensation in room (dewpoint sensor active)

6 🔔 Indicates fault or reminder

7 ⌚ Temporary comfort mode extension active

8 Additional user information, like outdoor temperature 🏠 or time of day from KNX bus. Selectable via parameters

9 🔒 Button lock active

10 1 2 3 4 5 6 7 Weekday 1...7 from KNX bus (1 = Monday / 7 = Sunday)

See "Reference documentation" on page 15 for information on how to engineer the KNX bus (topology, bus repeaters, etc.) and how to select and dimension connecting cables for supply voltage and field devices.

Mounting and installation

Mount the room thermostat on a conduit box. Do not mount on a wall in niches or bookshelves, behind curtains, above or near heat sources, or exposed to direct solar radiation. Mount about 1.5 m above the floor.

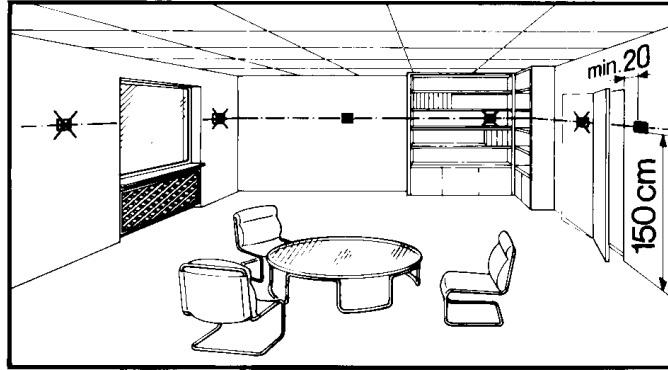

Mounting / Dismounting



- Mount the room thermostat on a clean, dry indoor place without direct airflow from a heating/cooling device, and not exposed to drips or splash water.
- In case of limited space in the conduit box use the mounting bracket ARG70.3 to increase the headroom by 10 mm.

Wiring

See the mounting instructions M3171... and M3076.1 enclosed with the thermostat.



- Comply with local regulations to wire, protection and earth the thermostat.

Warning!

No internal line protection for supply lines to external consumers (Q1, Q2, Q3, Yxx)

Risk of fire and injury due to short-circuits!

- Adapt the line diameters as per local regulations to the rated value of the installed overcurrent protection device.
- The AC 230 V mains supply line must have an external circuit breaker with a rated current of no more than 10 A.
- Properly size the cables to the thermostat, fan and valve actuators for AC 230 V mains voltage.
- Use only valve actuators rated for AC 230 V.
- Cables of SELV inputs X1-M/X2-M: Use cables with 230 V insulation, as the conduit box carries AC 230 V mains voltage.
- Inputs X1-M or X2-M of different units (e.g. summer/winter switch) may be connected in parallel with an external switch. Consider overall maximum contact sensing current for switch rating.
- KNX communication cables (input CE+ / CE-): Use cables with 230 V insulation, as the conduit box carries AC 230 V mains voltage.
- Disconnect from supply before opening the cover.
- When a KNX bus power supply is connected on the line with communicating thermostats and Synco controller, the internal KNX power supply of the Synco controllers must be switched off.



Applications

The room thermostats are delivered with a fixed set of applications.

Select and activate the relevant application during commissioning using one of the following tools:

- Local DIP switch and HMI
- Synco ACS
- ETS

Set the DIP switches before snapping the front panel to the mounting plate, if you want to select an application via **DIP switches**.

All DIP switches need to be set to "OFF" ("remote configuration"), if you want to select an application via **commissioning tool**.

After power is applied, the thermostat resets and all LCD segments flash, indicating that the reset was correct. After the reset, which takes about 3 seconds, the thermostat is ready for commissioning by qualified HVAC staff.

If all DIP switches are OFF, the display reads "NONE" to show that an application needs to be set via tool.

Note Each time the application is changed, the thermostat reloads the factory setting for all control parameters, except for KNX device and zone addresses!

Connect tool

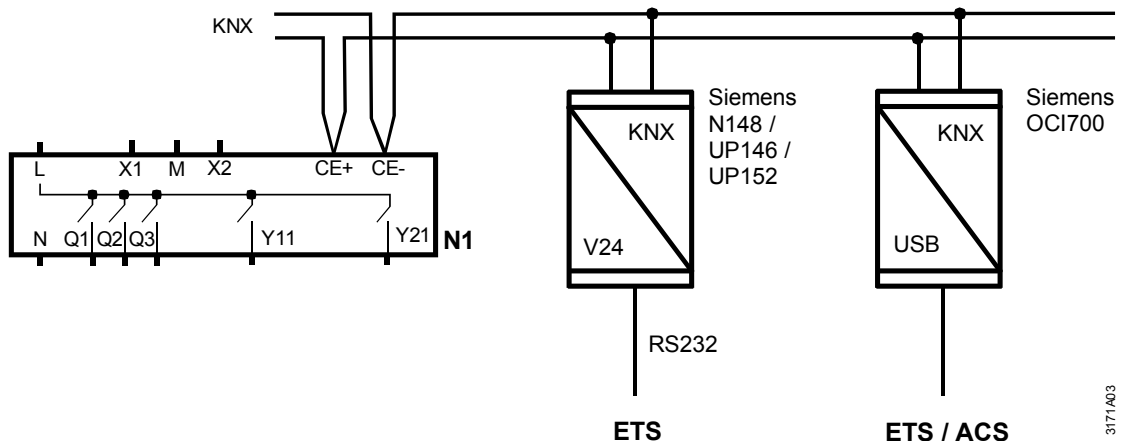

Connect the Synco ACS or ETS tools to the KNX bus cable at any point for commissioning:



ACS and ETS require an interface:

- RS232 KNX interface (e.g. Siemens N148 / UP146 / UP152)
- OCI700 USB- KNX interface

Note An external KNX bus power supply is required if an RDF301... / RDF600KN is connected directly to a tool (ACS or ETS) via KNX interface.

| | |
|--|--|
| Control parameters | <p>The thermostat's control parameters can be set to ensure optimum performance of the entire system (see basic documentation P3171).</p> <p>The parameters can be adjusted using</p> <ul style="list-style-type: none"> – Local HMI – Synco ACS – ETS |
| Control sequence | <ul style="list-style-type: none"> • The control sequence may need to be set via parameter P01 depending on the application. The factory setting for the 2-pipe application is "Cooling only"; and "Heating and Cooling" for the 4-pipe application. |
| Compressor-based application  | <ul style="list-style-type: none"> • When the thermostat is used with a compressor, adjust the minimum output on-time (parameter P48) and off-time (parameter P49) for Y11/Y21 to avoid damaging the compressor or shortening its life due to frequent switching. |
| Calibrate sensor | <ul style="list-style-type: none"> • Recalibrate the temperature sensor if the room temperature displayed on the thermostat does not match the room temperature measured (after min. 1 hour of operation). To do this, change parameter P05. |
| Setpoint and range limitation | <ul style="list-style-type: none"> • We recommend to review the setpoints and setpoint ranges (parameters P08...P12) and change them as needed to achieve maximum comfort and save energy. |
| Programming mode | <p>The programming mode helps identify the thermostat in the KNX network during commissioning.</p> <p>Press buttons "operating mode"  and "+" simultaneously for 6 sec to activate programming mode, which is indicated on the display with "PrOG".</p> <p>Programming mode remains active until thermostat identification is complete.</p> |
| Assign KNX device address | <p>Assign device address (P81) via HMI, ACS or ETS.</p> <p>With device address set to 255, the communication is deactivated (no exchange of process data).</p> |
| Assign KNX group addresses | <p>Use ETS to assign the KNX group addresses of the RDF communication objects.</p> |
| Switching groups RDF301.50... only | <p>RDF301.50 and RDF301.50H have 2 switching groups with a pair of buttons each, which must be configured via ETS. The switching groups only work on S-mode.</p> |
| KNX serial number | <p>Each device has a unique KNX serial number inside the front panel. An additional sticker with the same KNX serial number is enclosed in the packaging box. This sticker is intended for installers for documentation purposes.</p> |

Disposal



The devices are considered electronics devices for disposal in terms of European Directive 2012/19/EU and may not be disposed of as domestic waste.

- Dispose of the device via the channels provided for this purpose.
- Comply with all local and currently applicable laws and regulations.

Technical data

| | | |
|---|--|-------------------------------------|
| ⚠ Power supply | Rated voltage | AC 230 V |
| | Overvoltage category | III |
| | Frequency | 50/60 Hz |
| | Power consumption | |
| | RDF301... | Max. 4 VA / 3.0 W |
| | RDF600KN | Max. 3.5 VA / 1.2 W |
| ⚠ Caution | No internal fuse | |
| | External preliminary protection with max C 10 A circuit breaker required in all cases | |
| Outputs | Fan control Q1, Q2, Q3-N | AC 230 V |
| | Rating min, max resistive (inductive) | Min. 5 mA, Max. 5(2) A |
| STOP Note! | Fans must NOT be connected in parallel! | |
| | Connect one fan directly, for additional fans, one relay for each speed | |
| | Control output Y11-N / Y21-N (NO) | AC 230 V |
| | Rating min, max resistive (inductive) | Min. 5 mA, Max. 5(2) A |
| ⚠ Caution | Max. total load current through terminal "L" (Qx+Yxx) | Max. 7A |
| | No internal fuse | |
| | External preliminary protection with max. C 10 A circuit breaker in the supply line required under all circumstances | |
| | _____ | |
| Inputs | Multifunctional input X1-M/X2-M | |
| | Temperature sensor input: | |
| | Type | QAH11.1 (NTC) |
| | Temperature range | 0...49 °C |
| | Cable length | Max. 80 m |
| | Digital input: | |
| | Operating action | Selectable (NO / NC) |
| | Contact sensing | SELV DC 0...5 V/max 5 mA |
| | Parallel connection of several thermostats for one switch | Max. 20 thermostats per switch |
| | Insulation against mains voltage (SELV) | 4 kV, reinforced insulation |
| | Function of inputs: | Selectable |
| | External temperature sensor, heating/cooling changeover sensor, operating mode switchover contact, dewpoint monitor contact, enable electric heater contact, fault contact, monitoring input | X1: P38 X2: P40 |
| | _____ | |
| KNX bus | Interface type | KNX, TP1-64 (electrically isolated) |
| | Bus current RDF301 | 20 mA |
| | RDF600KN | 5 mA |
| Bus topology: See KNX manual (reference documentation, see below) | | |
| Operational data | Switching differential, adjustable | |
| | Heating mode (P30) | 2 K (0.5...6K) |
| | Cooling mode (P31) | 1 K (0.5...6K) |
| | Setpoint setting and range | |
| | ☀ Comfort (P08) | 21°C (5...40 °C) |
| | ☾ Economy (P11-P12) | 15°C/30°C (OFF, 5...40 °C) |
| | ☺ Protection (P65-P66) | 8°C/OFF (OFF, 5...40 °C) |
| | Multifunctional input X1/X2 | Selectable 0...8 |
| | Input X1 default value (P38) | 3 (Operating mode switchover) |
| | Input X2 default value (P40) | 1 (External temperature sensor) |

| | | |
|-----------------------------|--|--|
| | Built-in room temperature sensor | |
| | Measuring range | 0...49 °C |
| | Accuracy at 25 °C | < ± 0.5 K |
| | Temperature calibration range | ± 3.0 K |
| | Settings and display resolution | |
| | Setpoints | 0.5 °C |
| | Current temperature value displayed | 0.5 °C |
| Environmental conditions | Operation | |
| | Climatic conditions | As per IEC 60721-3-3 |
| | Temperature | Class 3K5 |
| | Humidity | 0...50 °C |
| | Transport | <95 % r.h. |
| | Transport | |
| | Climatic conditions | As per IEC 60721-3-2 |
| | Temperature | Class 2K3 |
| | Humidity | -25...60 °C |
| | Mechanical conditions | <95 % r.h. |
| Standards and directives | Storage | |
| | Climatic conditions | As per IEC 60721-3-1 |
| | Temperature | Class 1K3 |
| | Humidity | -25...60 °C |
| Standards and directives | EU conformity (CE) | RDF301... RDF600KN |
| | Electronic control type | CE1T3171xx ^{*)} CE1T3171xx_1 ^{*)} |
| |  RCM Mark conformity (Emission) | 2.B (micro-disconnection on operation) |
| | Safety class | RDF301... RDF600KN |
| | Pollution class | CE1T3171en_C1 ^{*)} CE1T3076en_C1 ^{*)} |
| | Degree of protection of housing | II as per EN 60730 Normal |
| Environmental Compatibility | IP 30 as per EN 60529 | |
| General | The product environmental declaration CE1E3076_3en ^{*)} (for RDF600KN) contains data on environmentally compatible product design and assessments (RoHS compliance, materials composition, packaging, environmental benefit, disposal). | |
| General | Connection terminals | |
| | Minimal wiring cross section on L, N, Q1, Q2, Q3, Y11, Y21 | Solid wires or prepared stranded wires |
| | | 1 x 0.4...1.5 mm ² min 1.5 mm ² |
| | Housing front color | RAL 9003 white |
| | Weight without / with packaging | RDF301.. 0.240 kg / 0.320 kg RDF600KN 0.150 kg / 0.220 kg |

^{*)} The documents can be downloaded from <http://siemens.com/bt/download>.

| | |
|--------------------------------|--|
| Reference documentation | Handbook for Home and Building Control - Basic Principles (http://www.knx.org/knx-en/training/books-documentation/knx-association-books/index.php) |
| Synco | CE1P3127 Communication via the KNX bus for Synco 700, 900 and RXB/RXL Basic documentation |
| Desigo | CM1Y9775 Desigo RXB integration – S-mode CM1Y9776 Desigo RXB / RXL integration – individual addressing CM1Y9777 Third-party integration CM1Y9778 Synco integration CM1Y9779 Working with ETS |
| Apogee | Installation Instruction: KNX Driver for PXC Modular; Document No. 565-132 Technical Spec Sheet: KNX Driver for PXC Modular; Document No. 127-1676 Technical Reference for KNX Driver; Document No. 140-0804 Application 6205 Point Map for RDF |

Connection terminals

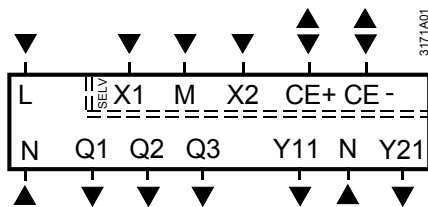

| | |
|----------|---|
| L, N | Operating voltage AC 230 V |
| Q1 | Control output "Fan speed 1 AC 230 V" |
| Q2 | Control output "Fan speed 2 AC 230 V" |
| Q3 | Control output "Fan speed 3 AC 230 V" |
| Y11, Y21 | Control output "Valve" AC 230 V (N.O., for normally closed valves), output for compressor or output for electric heater |
| X1, X2 | Multifunctional input for temperature sensor (e.g. QAH11.1) or potential-free switch Factory setting: – X1 = Operating mode switchover contact – X2 = External sensor (function can be selected via parameter P38 / P40). |
| M | Measuring neutral for sensor and switch |
| CE+ | KNX data + |
| CE- | KNX data - |

Connection diagrams

Application

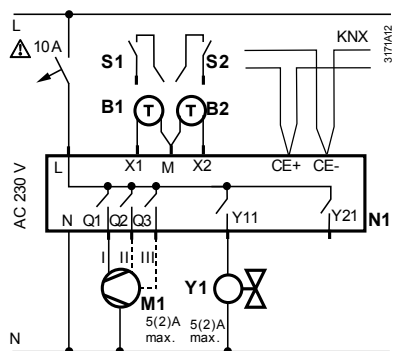

2-pipe, 2-position

2-pipe, 3-position
 - Y11 = Open
 - Y21 = Close

2-pipe and electric heater

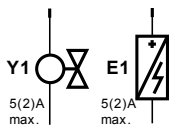

4-pipe
 - Y1 = Heating
 - Y2 = Cooling

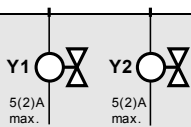

1-stage compressor
 - C1 = Heating and / or
 - C2 = Cooling)

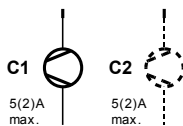

1-stage compressor and electric heater

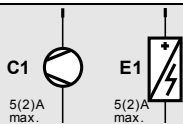

- N1 Room thermostat
RDF301... , RDF600KN
- M1 1-speed or 3-speed fan
- Y1 Valve actuator, 2-position or 3-position
- Y1, Y2 Valve actuator, 2-position
- E1 Electric heater
- C1, C2 1-stage compressor
- S1, S2 Switch (keycard, window contact, presence detector, etc.)
- B1, B2 Temperature sensor (return air temperature, external room temperature, changeover sensor, etc.)
- CE+ KNX data +
- CE- KNX data -

Dimensions

Dimensions in mm

